

Public Available Specification

CiA 301

Version 4.2.0

CANopen application layer and communication profile

February 21, 2011



HISTORY

Date	Changes
------	---------

1994-11-01	<i>Publication of version 1.0 as draft standard proposal</i>
------------	--

1995-01-01	<i>Publication of version 1.1 as draft standard proposal</i>
------------	--

1995-09-22	<i>Publication of version 2.0 as draft standard proposal</i>
------------	--

1996-10-30	<i>Publication of version 3.0 as draft standard</i>
------------	---

1999-06-16	<i>Publication of version 4.0 as draft standard</i>
------------	---

2000-06-01	<i>Publication of version 4.0.1 as draft standard</i>
------------	---

2002-02-13	<i>Publication of version 4.0.2 as draft standard</i>
------------	---

2006-08-15	<i>Publication of version 4.1 as draft standard proposal</i>
------------	--

2007-12-07	<i>Publication of version 4.2 as draft standard proposal</i>
------------	--

2011-02-21	<i>Publication of version 4.2.0 as public specification</i>
------------	---

NOTE: This document has been converted into "docx format".

The conversion caused minor layout differences to the predecessor document in "doc format". The technical content word-by-word is the very same.

General information on licensing and patents

CAN in AUTOMATION (CiA) calls attention to the possibility that some of the elements of this CiA specification may be subject of patent rights. CiA shall not be responsible for identifying any or all such patent rights.

Because this specification is licensed free of charge, there is no warranty for this specification, to the extent permitted by applicable law. Except when otherwise stated in writing the copyright holder and/or other parties provide this specification "as is" without warranty of any kind, either expressed or implied, including, but not limited to, the implied warranties of merchantability and fitness for a particular purpose. The entire risk as to the correctness and completeness of the specification is with you. Should this specification prove failures, you assume the cost of all necessary servicing, repair or correction.

CiA is committed to use inclusive language in its specifications and technical reports. CiA documents are going to be updated with the inclusive terms. A listing of the inclusive terms and the terms they substitute, is provided in the CiA house style document; provided at CiA website (<https://can-cia.org/s/housestyle>).

Trademarks

CANopen and CiA are registered community trademarks of CAN in Automation. The use is restricted for CiA members or owners of CANopen® vendor ID. More detailed terms for the use are available from CiA.

© CiA 2011

All rights reserved. Unless otherwise specified, no part of this publication may be reproduced or utilized in any form or by any means, electronic or mechanical, including photocopying and microfilm, without permission in writing from CiA at the address below.

CAN in Automation e. V.
Kontumazgarten 3
DE - 90429 Nuremberg, Germany
Tel.: +49-911-928819-0
Fax: +49-911-928819-79
Url: www.can-cia.org
Email: headquarters@can-cia.org

CONTENTS

1	Scope	12
2	References	13
2.1	Normative references	13
2.2	Informative references	13
3	Abbreviations and definitions	14
3.1	Abbreviations	14
3.2	Definitions	14
4	Modeling	16
4.1	Field device model	16
4.2	Communication reference model	17
4.2.1	General	17
4.2.2	CANopen application layer	17
4.2.2.1	General	17
4.2.2.2	Service primitives	17
4.2.2.3	Application layer services	18
4.3	CANopen device model	18
4.3.1	General	18
4.4	Communication protocol sequences	19
4.4.1	General	19
4.4.2	Master/slave protocol	19
4.4.3	Client/server protocol	20
4.4.4	Producer/consumer protocol – pull/push model	20
4.4.5	The object dictionary	21
4.5	Network system model	21
4.5.1	Device profile	21
4.5.2	Application profile	21
5	Physical layer	22
5.1	Reference to OSI model	22
5.2	Medium dependent interface	22
5.3	Physical medium attachment	22
5.4	Physical signaling	22
6	Data link layer	24
6.1	General	24
6.2	CAN frame type	24
7	Application layer	25
7.1	Data types and encoding rules	25
7.1.1	General description of data types and encoding rules	25
7.1.2	Data type definitions	25
7.1.3	Bit sequences	26
7.1.3.1	Definition of bit sequences	26
7.1.3.2	Transfer syntax for bit sequences	26
7.1.4	Basic data types	27
7.1.4.1	General	27
7.1.4.2	NIL	27

7.1.4.3	Boolean	27
7.1.4.4	Void	27
7.1.4.5	Unsigned Integer	27
7.1.4.6	Signed Integer	28
7.1.4.7	Floating-Point Numbers	28
7.1.5	Compound data types	29
7.1.6	Extended data types	30
7.1.6.1	General	30
7.1.6.2	Octet String	30
7.1.6.3	Visible String	30
7.1.6.4	Unicode String	30
7.1.6.5	Time of Day	30
7.1.6.6	Time Difference	30
7.1.6.7	Domain	31
7.2	Communication objects	31
7.2.1	General	31
7.2.2	Process data object (PDO)	31
7.2.2.1	General	31
7.2.2.2	Transmission modes	32
7.2.2.3	Triggering modes	33
7.2.2.4	PDO services	33
7.2.2.4.1	General	33
7.2.2.4.2	Service PDO write	33
7.2.2.4.3	Service PDO read	34
7.2.2.5	PDO protocol	34
7.2.2.5.1	Protocol PDO write	34
7.2.2.5.2	Protocol PDO read	35
7.2.3	Multiplex PDO (MPDO)	35
7.2.3.1	General	35
7.2.3.2	MPDO address modes	35
7.2.3.2.1	Destination address mode (DAM)	35
7.2.3.2.2	Source address mode (SAM)	35
7.2.3.3	MPDO service	36
7.2.3.3.1	General	36
7.2.3.3.2	Service MPDO write	36
7.2.3.4	MPDO protocol	36
7.2.3.4.1	Protocol MPDO write	36
7.2.4	Service data object (SDO)	37
7.2.4.1	General	37
7.2.4.2	SDO services	38
7.2.4.2.1	General	38
7.2.4.2.2	Service SDO download	39
7.2.4.2.3	Service SDO download initiate	39
7.2.4.2.4	Service SDO download segment	40
7.2.4.2.5	Service SDO upload	41
7.2.4.2.6	Service SDO upload initiate	41
7.2.4.2.7	Service SDO upload segment	42

7.2.4.2.8	Service SDO block download	43
7.2.4.2.9	Service SDO block download initiate	43
7.2.4.2.10	Service SDO block download sub-block	44
7.2.4.2.11	Service SDO block download end	44
7.2.4.2.12	Service SDO block upload	45
7.2.4.2.13	Service SDO block upload initiate.....	45
7.2.4.2.14	Service SDO block upload sub-block.....	46
7.2.4.2.15	Service SDO block upload end	47
7.2.4.2.16	Service SDO abort transfer	47
7.2.4.3	SDO protocols.....	48
7.2.4.3.1	General.....	48
7.2.4.3.2	Protocol SDO download	48
7.2.4.3.3	Protocol SDO download initiate	49
7.2.4.3.4	Protocol SDO download segment	50
7.2.4.3.5	Protocol SDO upload.....	50
7.2.4.3.6	Protocol SDO upload initiate	51
7.2.4.3.7	Protocol SDO upload segment.....	52
7.2.4.3.8	Protocol SDO block download.....	53
7.2.4.3.9	Protocol SDO block download initiate	53
7.2.4.3.10	Protocol SDO block download sub-block.....	55
7.2.4.3.11	Protocol SDO block download end	56
7.2.4.3.12	Protocol SDO block upload	57
7.2.4.3.13	Protocol SDO block upload initiate	58
7.2.4.3.14	Protocol SDO block upload sub-block	59
7.2.4.3.15	Protocol SDO block upload end	59
7.2.4.3.16	CRC calculation algorithm to verify SDO block transfer	60
7.2.4.3.17	Protocol SDO abort transfer	61
7.2.5	Synchronization object (SYNC).....	62
7.2.5.1	General	62
7.2.5.2	SYNC services.....	62
7.2.5.2.1	General	62
7.2.5.2.2	Service SYNC write.....	62
7.2.5.3	SYNC protocol	63
7.2.5.3.1	Protocol SYNC write.....	63
7.2.6	Time stamp object (TIME)	63
7.2.6.1	General	63
7.2.6.2	TIME services	63
7.2.6.2.1	General	63
7.2.6.2.2	Service TIME write	63
7.2.6.3	TIME protocol.....	64
7.2.6.3.1	Protocol TIME write	64
7.2.7	Emergency object (EMCY).....	64
7.2.7.1	Emergency object usage	64
7.2.7.2	Emergency object services.....	67
7.2.7.2.1	General	67
7.2.7.2.2	Service EMCY write	67
7.2.7.3	Emergency object protocol	67

7.2.7.3.1	Protocol EMCY write	67
7.2.8	Network management	68
7.2.8.1	General	68
7.2.8.2	NMT services	68
7.2.8.2.1	Node control services	68
7.2.8.2.2	Error control services	70
7.2.8.2.3	Boot-up service.....	72
7.2.8.3	NMT protocols.....	72
7.2.8.3.1	Node control protocols	72
7.2.8.3.2	Error Control Protocols	74
7.2.8.3.3	Protocol boot-up	77
7.3	Network initialization and system boot-up	77
7.3.1	Simplified NMT startup	77
7.3.2	NMT state machine	77
7.3.2.1	Overview	77
7.3.2.2	NMT states.....	78
7.3.2.2.1	NMT state Initialisation	78
7.3.2.2.2	NMT state Pre-operational	79
7.3.2.2.3	NMT state Operational	79
7.3.2.2.4	NMT state Stopped	79
7.3.2.2.5	NMT states and communication object relation	80
7.3.2.3	NMT state transitions.....	80
7.3.3	Generic pre-defined connection set	80
7.3.4	Specific pre-defined connection set	81
7.3.5	Restricted CAN-IDs	81
7.4	Object dictionary	82
7.4.1	General structure.....	82
7.4.2	Index and sub-index usage	83
7.4.3	Object code usage.....	84
7.4.4	Data type usage	84
7.4.5	Access usage	85
7.4.6	Category and entry category usage	85
7.4.7	Data type entry usage	85
7.4.7.1	General	85
7.4.7.2	Organization of structured object dictionary entries	88
7.4.8	Specification of pre-defined complex data types.....	88
7.4.8.1	PDO communication parameter record specification	88
7.4.8.2	PDO mapping parameter record specification	88
7.4.8.3	SDO parameter record specification	89
7.4.8.4	Identity record specification	89
7.4.8.5	OS debug record specification	89
7.4.8.6	OS Command record specification	90
7.5	Communication profile specification	90
7.5.1	Object and entry description specification.....	90
7.5.2	Detailed specification of communication profile specific objects	91
7.5.2.1	Object 1000 _h : Device type	91
7.5.2.2	Object 1001 _h : Error register.....	92

7.5.2.3	Object 1002 _h : Manufacturer status register	93
7.5.2.4	Object 1003 _h : Pre-defined error field	93
7.5.2.5	Object 1005 _h : COB-ID SYNC message	95
7.5.2.6	Object 1006 _h : Communication cycle period	96
7.5.2.7	Object 1007 _h : Synchronous window length	97
7.5.2.8	Object 1008 _h : Manufacturer device name	97
7.5.2.9	Object 1009 _h : Manufacturer hardware version	98
7.5.2.10	Object 100A _h : Manufacturer software version	98
7.5.2.11	Object 100C _h : Guard time	98
7.5.2.12	Object 100D _h : Life time factor	99
7.5.2.13	Object 1010 _h : Store parameters	100
7.5.2.14	Object 1011 _h : Restore default parameters	102
7.5.2.15	Object 1012 _h : COB-ID time stamp object	105
7.5.2.16	Object 1013 _h : High resolution time stamp	106
7.5.2.17	Object 1014 _h : COB-ID EMCY	106
7.5.2.18	Object 1015 _h : Inhibit time EMCY	107
7.5.2.19	Object 1016 _h : Consumer heartbeat time	107
7.5.2.20	Object 1017 _h : Producer heartbeat time	109
7.5.2.21	Object 1018 _h : Identity object	109
7.5.2.22	Object 1019 _h : Synchronous counter overflow value	111
7.5.2.23	Object 1020 _h : Verify configuration	112
7.5.2.24	Object 1021 _h : Store EDS	114
7.5.2.25	Object 1022 _h : Store format	114
7.5.2.26	Object 1023 _h : OS command	116
7.5.2.27	Object 1024 _h : OS command mode	117
7.5.2.28	Object 1025 _h : OS debugger interface	118
7.5.2.29	Object 1026 _h : OS prompt	119
7.5.2.30	Object 1027 _h : Module list	120
7.5.2.31	Object 1028 _h : Emergency consumer object	122
7.5.2.32	Object 1029 _h : Error behavior object	123
7.5.2.33	Object 1200 _h to 127F _h : SDO server parameter	125
7.5.2.34	Object 1280 _h to 12FF _h : SDO client parameter	127
7.5.2.35	Object 1400 _h to 15FF _h : RPDO communication parameter	129
7.5.2.36	Object 1600 _h to 17FF _h : RPDO mapping parameter	134
7.5.2.37	Object 1800 _h to 19FF _h : TPDO communication parameter	136
7.5.2.38	Object 1A00 _h to 1BFF _h : TPDO mapping parameter	141
7.5.2.39	Object 1FA0 _h to 1FCF _h : Object scanner list	144
7.5.2.40	Object 1FD0 _h to 1FFF _h : Object dispatching list	145
Annex A (informative)		148
Implementation Recommendations		148
Invalid COB's		148
Time-out's		148
PDO Transmission Type 0, 254, 255		148
Overview object dictionary objects for communication		148

Tables

Table 1: Recommended bit timing settings	22
Table 2: Estimated bus lengths	23
Table 3: Example PDO number calculation	32
Table 4: Service PDO write	33
Table 5: Service PDO read	34
Table 6: Service MPDO write	36
Table 7: Service SDO download	39
Table 8: Service SDO download initiate	40
Table 9: Service SDO download segment	40
Table 10: Service SDO upload	41
Table 11: Service SDO upload initiate	42
Table 12: Service SDO upload segment	42
Table 13: Service SDO block download	43
Table 14: Service SDO block download initiate	43
Table 15: Service SDO block download sub-block	44
Table 16: Service SDO block download end	45
Table 17: Service SDO block upload	45
Table 18: Service SDO block upload initiate	46
Table 19: Service SDO block upload sub-block	46
Table 20: Service SDO block upload end	47
Table 21: Service SDO abort transfer	47
Table 22: SDO abort codes	61
Table 23: Service SYNC write	63
Table 24: Service TIME write	64
Table 25: Emergency error code classes	64
Table 26: Emergency error codes	65
Table 27: Service EMCY write	67
Table 28: Service start remote node	68
Table 29: Service stop remote node	69
Table 30: Service enter pre-operational	69
Table 31: Service reset node	69
Table 32: Service reset communication	70
Table 33: Service node guarding event	71
Table 34: Service life guarding event	71
Table 35: Service heartbeat event	72
Table 36: Service boot-up event	72
Table 37: NMT states and communication objects	80
Table 38: Broadcast objects of the generic pre-defined connection set	81
Table 39: Peer-to-peer objects of the generic pre-defined connection set	81
Table 40: Restricted CAN-IDs	82
Table 41: Object dictionary structure	82
Table 42: Object Dictionary object definitions	84
Table 43: Access attributes for data objects	85
Table 44: Object dictionary data types	85
Table 45: complex data type example	87

Table 46: PDO communication parameter record	88
Table 47: PDO mapping parameter record	88
Table 48: SDO parameter record	89
Table 49: Identity record	89
Table 50: OS debug record	89
Table 51: OS command record	90
Table 52: Format of an object description	90
Table 53: Object value description format	91
Table 54: Structure of the error register	92
Table 55: Description of SYNC COB-ID	95
Table 56: Structure of read access	100
Table 57: Structure of restore read access	103
Table 58: Description of TIME COB-ID	105
Table 59: Description of EMCY COB-ID	106
Table 60: Values for EDS store formats	115
Table 61: OS command mode values	117
Table 62: Description of EMCY COB-ID	122
Table 63: Error class values	124
Table 64: Description of SDO server COB-ID	125
Table 65: Description of SDO client COB-ID	128
Table 66: Description of RPDO COB-ID	130
Table 67: Generic pre-defined connection set for RPDO	130
Table 68: Description of RPDO transmission type	131
Table 69: RPDO mapping values	134
Table 70: Description of TPDO COB-ID	137
Table 71: Generic pre-defined connection set for TPDO	137
Table 72: Description of TPDO transmission type	138
Table 73: TPDO mapping values	141
Table 74: Standard objects	148

Figures

Figure 1: Field device model	16
Figure 2: Minimum field device	17
Figure 3: Communication reference model	17
Figure 4: Application layer services	18
Figure 5: CANopen device model	19
Figure 6: Unconfirmed master/slave communication protocol	19
Figure 7: Confirmed master/slave communication protocol	20
Figure 8: Client/server communication protocol	20
Figure 9: Push model	20
Figure 10: Pull model	21
Figure 11: Physical layer reference model	22
Figure 12: Transfer syntax for bit sequences	27
Figure 13: Transfer syntax for data type UNSIGNEDn	28
Figure 14: Transfer syntax for data type INTEGERn	28
Figure 15: Transfer syntax of data type REAL32	29
Figure 16: Synchronous and event-driven transmission	32
Figure 17: Protocol PDO write	34
Figure 18: Protocol PDO read	35
Figure 19: Protocol MPDO write	37
Figure 20: Protocol SDO download	48
Figure 21: Protocol SDO download initiate	49
Figure 22: Protocol SDO segment download	50
Figure 23: Protocol SDO upload	50
Figure 24: Protocol SDO upload initiate	51
Figure 25: Protocol SDO segment upload	52
Figure 26: Protocol SDO block download	53
Figure 27: Protocol SDO block download initiate	54
Figure 28: Protocol SDO block download sub-block	55
Figure 29: Protocol SDO block download end	56
Figure 30: Protocol SDO block upload	57
Figure 31: Protocol SDO block upload initiate	58
Figure 32: Protocol SDO block upload sub-block	59
Figure 33: Protocol SDO block upload end	60
Figure 34: Protocol SDO abort transfer	61
Figure 35: Protocol SYNC write	63
Figure 36: Protocol TIME write	64
Figure 37: Emergency state transition diagram	67
Figure 38: Protocol EMCY write	68
Figure 39: Protocol start remote node	72
Figure 40: Protocol stop remote node	73
Figure 41: Protocol enter pre-operational	73
Figure 42: Protocol reset node	73
Figure 43: Protocol reset communication	74
Figure 44: Protocol node guarding	75
Figure 45: Protocol heartbeat	76

Figure 46: Protocol boot-up.....	77
Figure 47: NMT startup simple.....	77
Figure 48: NMT state diagram of a CANopen device	78
Figure 49: Structure of the NMT state Initialization.....	79
Figure 50: CAN-ID-allocation scheme for the generic pre-defined connection set	80
Figure 51: Structure sub-index FF _h	88
Figure 52: Structure of the device type parameter	92
Figure 53: Structure of the pre-defined error field.....	94
Figure 54: Structure of SYNC COB-ID.....	95
Figure 55: Storage write access signature.....	100
Figure 56: Storage read access structure.....	100
Figure 57: Restore default write access signature.....	102
Figure 58: Restore procedure	103
Figure 59: Restore default read access structure.....	103
Figure 60: Structure of TIME COB-ID	105
Figure 61: Structure of the EMCY Identifier	106
Figure 62: Structure of Consumer heartbeat time.....	108
Figure 63: Structure of revision number.....	110
Figure 64: Structure of EMCY COB-ID	122
Figure 65: Structure of SDO server COB-ID	125
Figure 66: Structure of SDO client COB-ID	127
Figure 67: Structure of RPDO COB-ID	130
Figure 68: Bus synchronization and actuation	131
Figure 69: Structure of RPDO mapping	134
Figure 70: Principle of RPDO mapping	135
Figure 71: Structure of TPDO COB-ID.....	137
Figure 72: Bus synchronization and sampling	139
Figure 73: Structure of TPDO mapping	142
Figure 74: Principle of TPDO mapping	143
Figure 75: Object scanner list object entry.....	144
Figure 76: Object dispatching list object entry	145

1 Scope

This specification specifies the CANopen application layer. This includes the data types, encoding rules and object dictionary objects as well as the CANopen communication services and protocols. In addition, this specification specifies the CANopen network management services and protocols.

This specification specifies the CANopen communication profile, e.g. the physical layer, the pre-defined communication object identifier connection set, and the content of the Emergency, Timestamp, and Sync communication objects.

2 References

2.1 Normative references

- /EN61131-3/ EN 61131-3, Programmable controllers – Part 3: Programming languages
- /ISO7498-1/ ISO 7498-1, Information technology – Open Systems Interconnection – Basic Reference Model: The Basic Model
- /ISO8859/ ISO 8859, Information technology – 8-bit single-byte coded graphic character sets
- /ISO11898-1/ ISO 11898-1, Road vehicles – Controller area network (CAN) – Part 1: Data link layer and physical signaling
- /ISO11898-2/ ISO 11898-2, Road vehicles – Controller area network (CAN) – Part 2: High-speed medium access unit
- /ISO11898-3/ ISO 11898-3, Road vehicles – Controller area network (CAN) – Part 3: Low-speed, fault-tolerant, medium-dependent interface
- /ISO10646/ ISO 10646, Information technology – Universal multiple-octet coded character set (UCS)

2.2 Informative references

- /IEEE754/ IEEE 754, Standard for binary floating-point arithmetic
- /IEC62390/ IEC TR 62390, Common automation device – Profile guideline

3 Abbreviations and definitions

3.1 Abbreviations

ARQ	Automatic repeat request
CAN	Controller area network
CAN-ID	CAN identifier
COB	Communication object
COB-ID	COB identifier
CRC	Cyclic redundancy check
CSDO	Client-SDO
DAM	Destination address mode
FSA	Finite state automaton
LLC	Logical link control
LSB	Least significant bit/byte
MAC	Medium access control
MDI	Medium dependent interface
MPDO	Multiplexed-PDO
MSB	Most significant bit/byte
NMT	Network management
Node-ID	Node identifier
OSI	Open systems interconnection
PDO	Process data object
PLS	Physical layer signaling
PMA	Physical medium attachment
RPDO	Receive-PDO
RTR	Remote transmission request
SAM	Source address mode
SDO	Service data object
SSDO	Server-SDO
SYNC	Synchronization object
TPDO	Transmit-PDO

3.2 Definitions

CAN base frame

message that contains up to 8 byte and is identified by 11 bits as defined in /ISO11898-1/

CAN extended frame

message that contains up to 8 byte and is identified by 29 bits as defined in /ISO11898-1/

CAN-ID

identifier for CAN data and remote frames as defined in /ISO11898-1/

COB-ID

identifier that contains the CAN-ID and additional control bits

Entity

particular thing, such as a person, place, process, concept, association, or event

FSA

model of computation consisting of a set of states, a start state, an input alphabet, and a transition function that maps input symbols and current states to a next state; computation begins in the start state with an input string; it changes to new states depending on the transition function

Field device

1. networked independent physical entity of an automation system capable of performing specified functions in a particular context and delimited by its interfaces
2. entity that performs control, actuating and/or sensing functions and interfaces to other such entities within an automation system

Logical device

representation of a field device in terms of its objects and behavior according to a field device model that describes the device's data and behavior as viewed through a network

Node-ID

network-wide unique identifier for each CANopen device

Object

entity with a well-defined boundary and identity that encapsulates state and behavior

Virtual device

entity of software capable of accomplishing a functional element of a field device

4 Modeling

4.1 Field device model

The field device shown in Figure 1 shall have at least one CANopen device. Each CANopen device within the field device shall have at least one associated network interface comprising a data link layer protocol (see clause 6) and a physical layer definition (see clause 5), one node-ID, and at least one communication FSA. The first communication FSA contains the NMT slave state machine (see sub-clause 7.3.2). Additional communication FSAs contain an emergency state machine (see sub-clause 7.2.7) and others. The definition of additional communication FSAs does not fall into the scope of this specification. The definition is made in so-called frameworks. A CANopen device shall have at least one and up to eight logical devices and shall not be distributed to several field devices. Each logical device may contain a number of virtual devices and optionally a logical device FSA. A logical device shall not be distributed to several CANopen devices. The definition of a logical device does not fall into the scope of this specification. The definition is made in so-called device profiles (see sub-clause 4.5.1). A virtual device contains a virtual device FSA and is not distributed to several logical devices. The definition of a virtual device does not fall into the scope of this specification. The definition is made in so-called application profiles (see sub-clause 4.5.2). The minimum field device is shown in Figure 2.

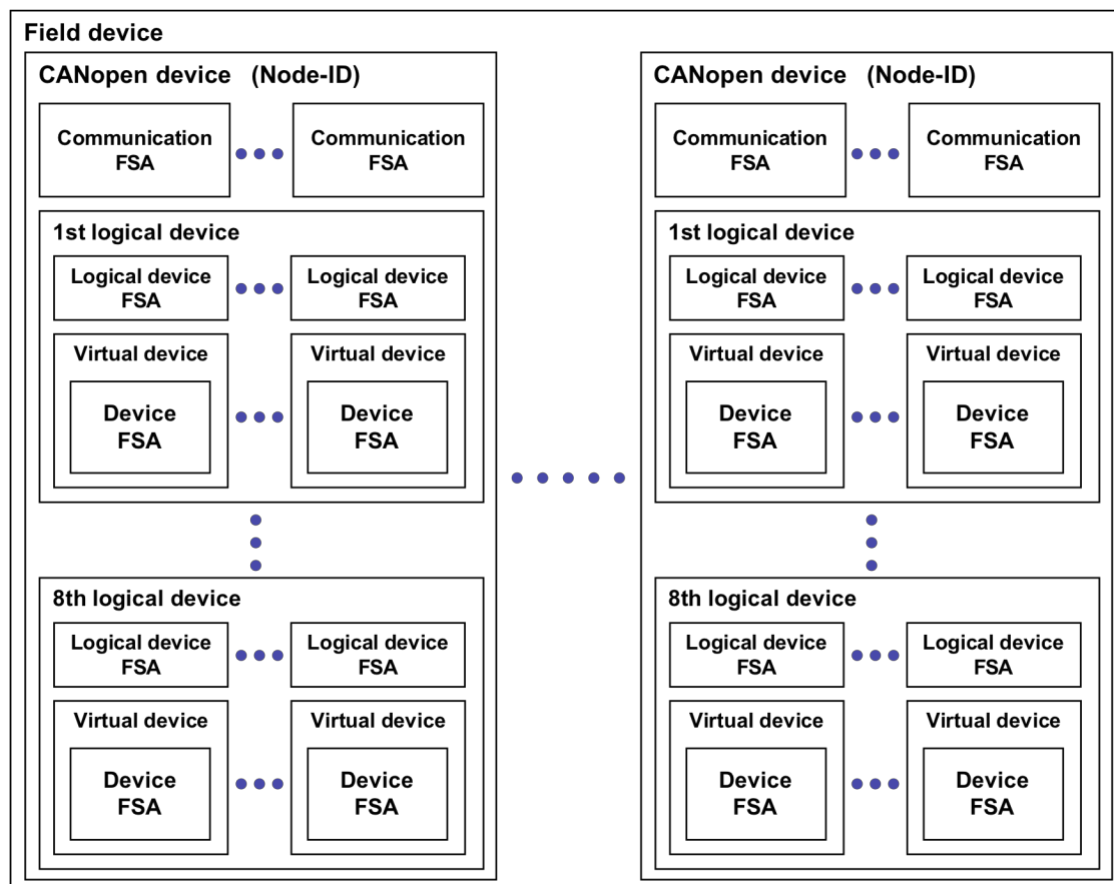

Figure 1: Field device model

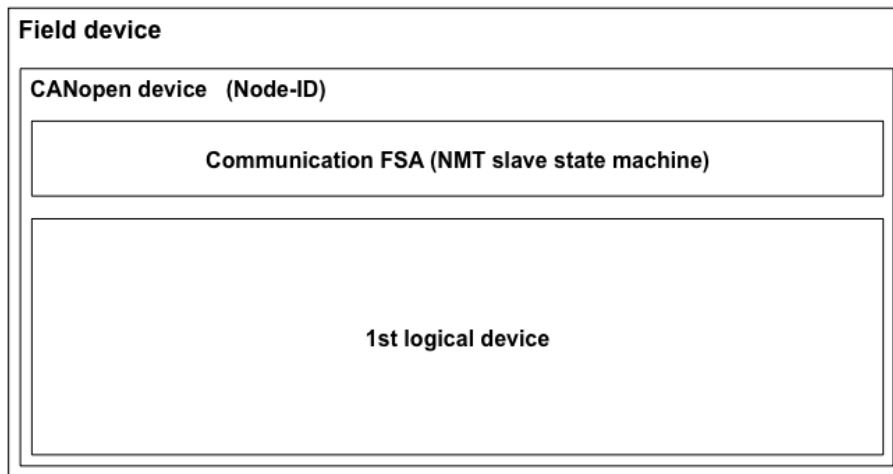

Figure 2: Minimum field device

4.2 Communication reference model

4.2.1 General

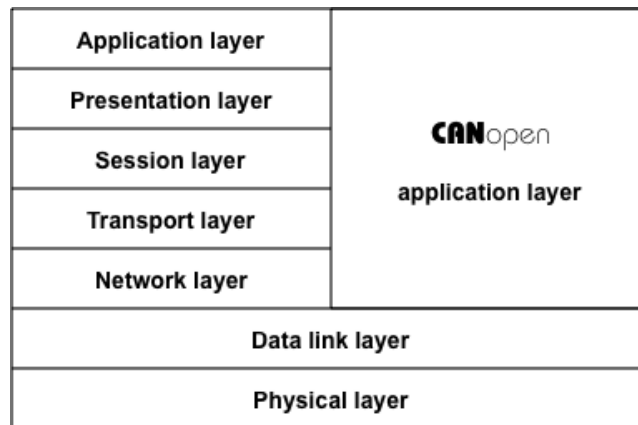

Figure 3: Communication reference model

The communication concept conforms to the ISO-OSI reference model (left side of Figure 3; see /ISO7498-1/).

4.2.2 CANopen application layer

4.2.2.1 General

The application layer describes a concept to configure and communicate real-time data as well as the mechanisms for synchronization between CANopen devices. The functionality the application layer offers to an application is logically divided over different *service objects* in the application layer. A service object offers a specific functionality and all the related services. These services are described in the *service specification* of that service object.

An application interacts by invoking services of a service object in the application layer. To realize these services, this object exchanges data via the data link layer with (a) peer service object(s) via a protocol. This protocol is described in the *protocol specification* of that service object.

4.2.2.2 Service primitives

Service primitives are the means by which the application and the application layer interact. There are four different primitives:

- A *request* is issued by the application to the application layer to request a service.
- An *indication* is issued by the application layer to the application to report an internal event detected by the application layer or indicate that a service is requested.
- A *response* is issued by the application to the application layer to respond to a previous received indication.

- A *confirmation* is issued by the application layer to the application to report the result of a previously issued request.

4.2.2.3 Application layer services

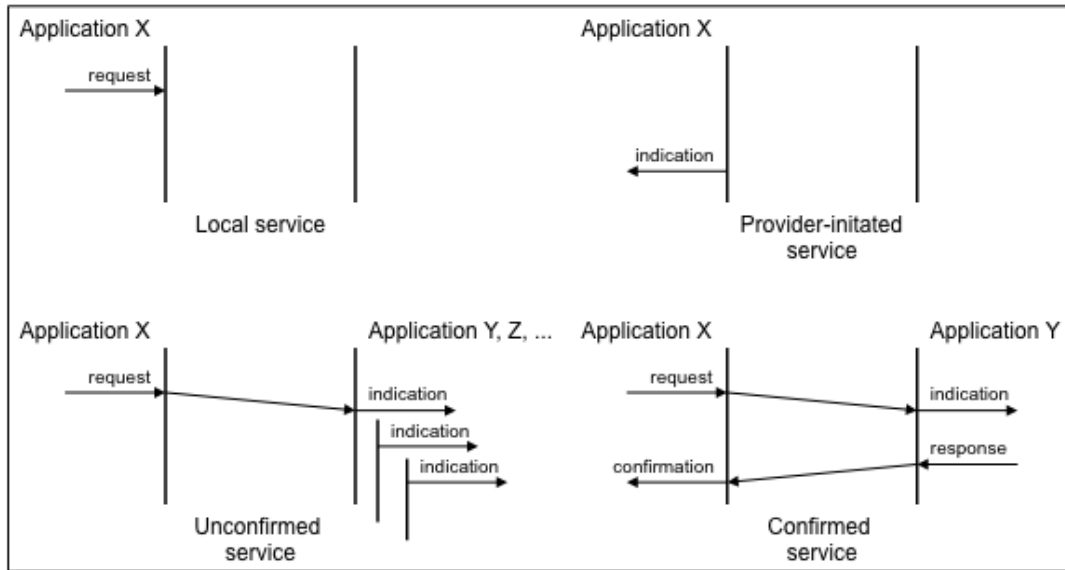

Figure 4: Application layer services

An application layer service defines the primitives that are exchanged between the application layer and the co-operating applications for a particular service of a service object. The application layer services supported by CANopen are shown in Figure 4.

- A local service involves only the local service object. The application issues a request to its local service object that executes the requested service without communicating with (a) peer service object(s).
- A provider-initiated service involves only the local service object. The service object (being the service provider) detects an event not solicited by a requested service. This event is then indicated to the application.
- An unconfirmed service involves one or more peer service objects. The application issues a request to its local service object. This request is transferred to the peer service object(s) that each passes it to their application as an indication. The result is not confirmed back.
- A confirmed service involves only one peer service object. The application issues a request to its local service object. This request is transferred to the peer service object that passes it to the other application as an indication. The other application issues a response that is transferred to the originating service object that passes it as a confirmation to the requesting application.

Unconfirmed and confirmed services are collectively called remote services.

4.3 CANopen device model

4.3.1 General

A CANopen device is structured like the following (shown in Figure 5):

- **Communication** – This function unit provides the communication objects and the appropriate functionality to transport data items via the underlying network structure.
- **Object dictionary** – The object dictionary is a collection of all the data items which have an influence on the behavior of the application objects, the communication objects and the state machine used on this device.
- **Application** – The application comprises the functionality of the device with respect to the interaction with the process environment.

Thus the object dictionary serves as an interface between the communication and the application.

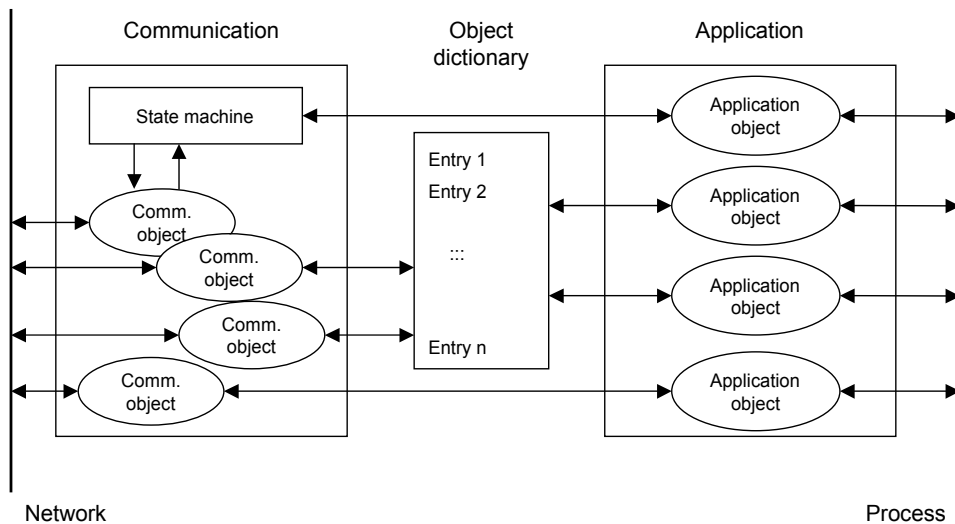

Figure 5: CANopen device model

4.4 Communication protocol sequences

4.4.1 General

The communication protocol sequences describe the different communication protocol principles and the available modes of message transmission triggering.

The CANopen communication protocol sequences support the transmission of synchronous and event-driven messages. By means of synchronous message transmission a network wide coordinated data acquisition and actuation is possible. The synchronous transmission of messages is supported by pre-defined communication objects. Synchronous messages are transmitted with respect to a pre-defined synchronization message; event-driven messages are transmitted at any time.

Due to the event character of the underlying communication mechanism it is possible to define inhibit times for the communication. To guarantee that no starvation on the network occurs for communication objects with low priorities, it is possible to assign an inhibit time to the communication object. The inhibit-time of a communication object defines the minimum time that elapses between two consecutive invocations of a transmission service for that communication object.

With respect to their functionality, three types of communication protocol models are distinguished

- Master/Slave protocol (see sub-clause 4.4.2)
- Client/Server protocol (see sub-clause 4.4.3)
- Producer/Consumer protocol (see sub-clause 4.4.4)

4.4.2 Master/slave protocol

At any time there is exactly one CANopen device in the network serving as a master for a specific functionality. All other CANopen devices in the network are considered as slaves. The master issues a request and the addressed slave(s) responds(respond) if the protocol requires this behavior. Figure 6 defines the unconfirmed master/slave communication protocol. Figure 7 defines the confirmed master/slave communication protocol.

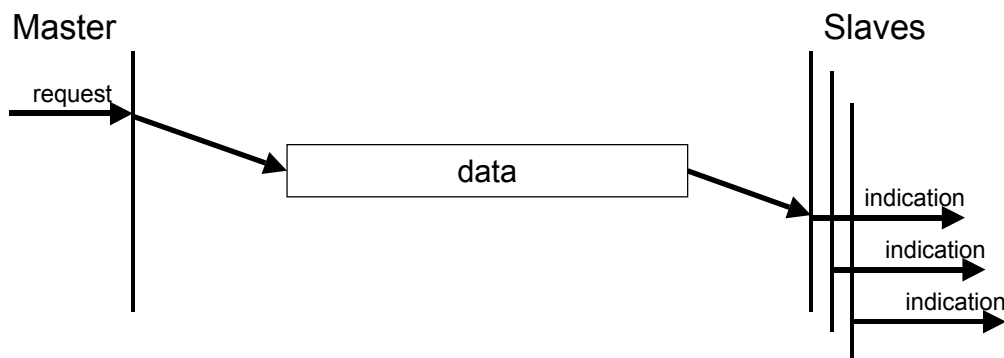

Figure 6: Unconfirmed master/slave communication protocol

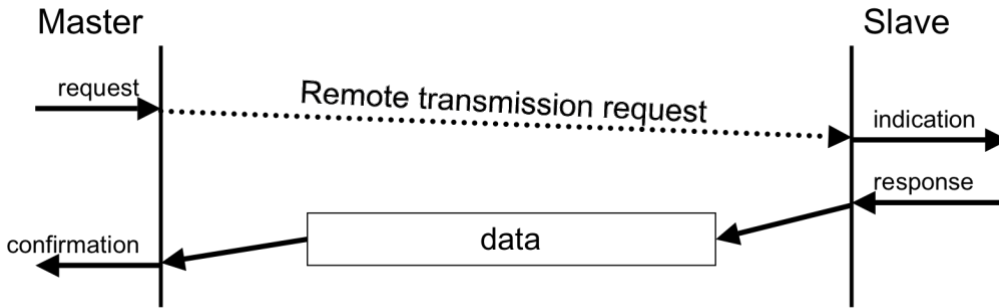

Figure 7: Confirmed master/slave communication protocol

4.4.3 Client/server protocol

This is a communication protocol used between a single client and a single server. A client issues a request (upload/download) thus triggering the server to perform a certain task. After finishing the task the server answers the request. Figure 8 defines the client/server communication protocol.

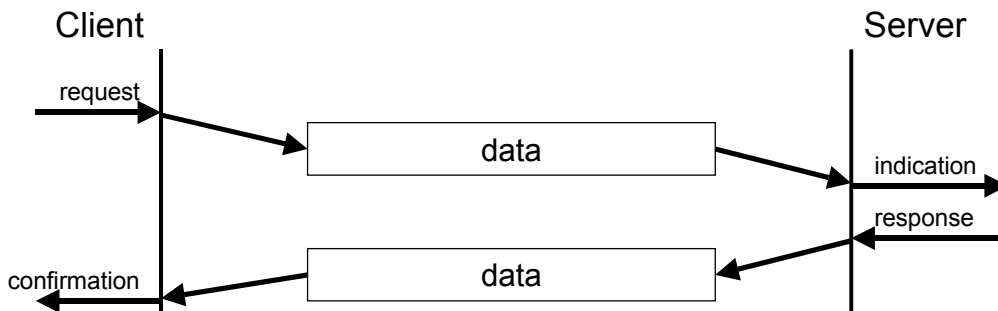

Figure 8: Client/server communication protocol

4.4.4 Producer/consumer protocol – pull/push model

The producer/consumer protocol involves a producer and zero or more consumer(s). The push model as defined in Figure 9 is characterized by an unconfirmed protocol requested by the producer. The pull model as defined in Figure 10 is characterized by a confirmed protocol requested by the consumer.

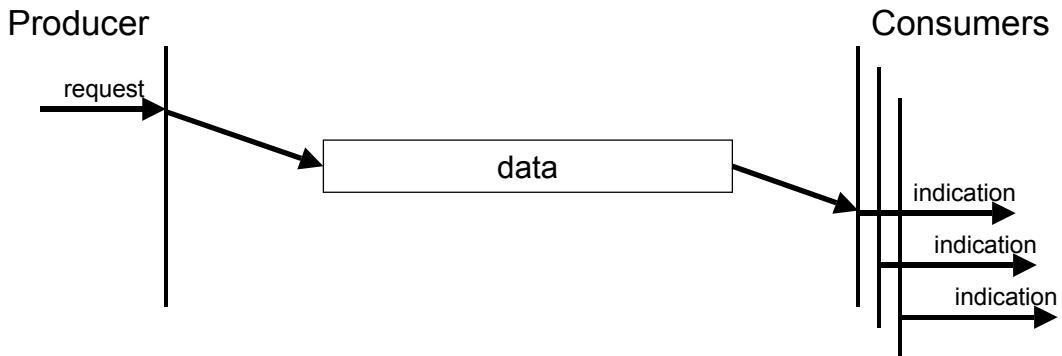

Figure 9: Push model

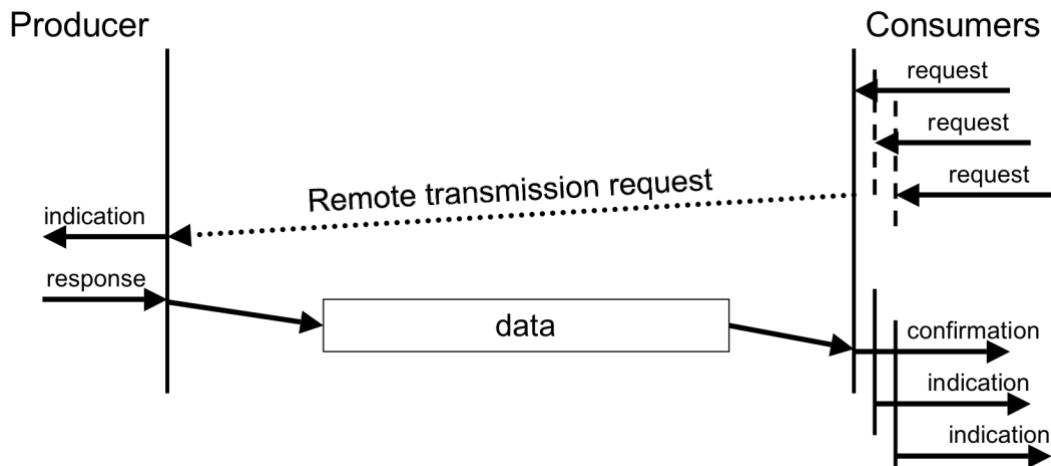

Figure 10: Pull model

4.4.5 The object dictionary

The object dictionary is essentially a grouping of objects accessible via the network in an ordered pre-defined fashion. Each object within the object dictionary is addressed using a 16-bit index and a 8-bit sub-index.

4.5 Network system model

4.5.1 Device profile

A device profile is a description of the objects of the object dictionary of one logical device comprising one virtual device. This description includes a functional description of the objects and a formal description of the objects. The functional description defines the behavior of an object within the object dictionary. The formal description defines whether an object shall be implemented or may be implemented as well as the access from and to the CANopen network. The access depends on the method on how an object is accessed.

4.5.2 Application profile

The application profile is a description of the objects of the object dictionary of one virtual device and includes a network wide configuration of all CANopen devices. This description includes a functional description of the objects and a formal description of the objects. The functional description defines the behavior of an object within the object dictionary. The formal description defines whether an object shall be implemented or may be implemented as well as the access from and to the network. The access depends on the method on how an index and sub-index is accessed.

5 Physical layer

5.1 Reference to OSI model

According to the OSI reference model the physical layer (shown in Figure 11) is divided into three sub-layers:

- Medium dependent interface,
- Physical medium attachment, and
- Physical signaling.

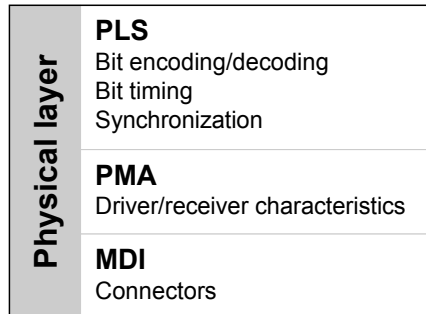

Figure 11: Physical layer reference model

5.2 Medium dependent interface

The medium dependent interface does not fall within the scope of this specification.

5.3 Physical medium attachment

The physical medium for a CANopen device should be a differentially driven two-wire bus line with common return according to high-speed transmission specification in /ISO11898-2/.

NOTE Other physical medium access technologies such as /ISO11898-3/ may be used.

Using the high-speed transceiver according to /ISO11898-2/ the maximum rating for V_{CAN_H} and V_{CAN_L} shall be +16V. Galvanic isolation between CANopen devices is optional. It is recommended to use a transceiver that is capable of sustaining misconnection of any of the wires of the connector including the optional V+ voltages of up to 30 V.

5.4 Physical signaling

The bit encoding/decoding and synchronization shall meet the requirements defined in /ISO11898-1/.

The bit timing shall meet the requirements defined in /ISO11898-1/ and it is recommended to follow the definitions as given in Table 1 (the according bus length estimations are shown in Table 2). One of these bit-rates shall be supported, additional bit-rates may be supported.

Table 1: Recommended bit timing settings

Bit rate	Nominal bit time t_b	Valid range for location of sample point	Recommended location of sample point
1 Mbit/s	1 μ s	75% to 90%	87,5%
800 kbit/s	1,25 μ s	75% to 90%	87,5%
500 kbit/s	2 μ s	85% to 90%	87,5%
250 kbit/s	4 μ s	85% to 90%	87,5%
125 kbit/s	8 μ s	85% to 90%	87,5%
50 kbit/s	20 μ s	85% to 90%	87,5%
20 kbit/s	50 μ s	85% to 90%	87,5%
10 kbit/s	100 μ s	85% to 90%	87,5%

Table 2: Estimated bus lengths

Bit rate	Bus length⁽¹⁾
1 Mbit/s	25 m
800 kbit/s	50 m
500 kbit/s	100 m
250 kbit/s	250 m
125 kbit/s	500 m
50 kbit/s	1.000 m
20 kbit/s	2.500 m
10 kbit/s	5.000 m

Note 1: The bus length estimation is based on the recommended location of the sample point.

The bus length estimation is based on a propagation delay of 5 ns/m. The delay times of used CAN controllers, CAN transceivers, and optocouplers need to be considered in addition.

6 Data link layer

6.1 General

The described networks shall be based on a data link layer and its sub-layers according to /ISO11898-1/.

6.2 CAN frame type

This specification is based on the CAN base frames with 11-bit CAN-ID. It is not required to support the CAN extended frame with 29-bit identifier field.

NOTE: However, as certain applications require the usage of the CAN extended frame with 29-bit CAN-ID the network is operated in this mode as well if it is supported at all CANopen devices.

7 Application layer

7.1 Data types and encoding rules

7.1.1 General description of data types and encoding rules

To be able to exchange meaningful data across the network, it is necessary that the format of this data and its meaning is known by the producer and consumer(s). This specification models this by the concept of data types.

The encoding rules define the representation of values of data types and the transfer syntax for the representations. Values are represented as bit sequences. Bit sequences are transferred in sequences of octets (bytes). For numerical data types the encoding is little endian style.

Applications often require data types beyond the basic data types. Using the compound data type mechanism, it is possible to extend the list of available data types. Some general extended data types are defined as "Visible String" or "Time of Day" for example (see sub-clause 7.1.6.3 and sub-clause 7.1.6.5). Compound data types are a means to implement user defined "DEFTYPES" in the terminology of this specification and not "DEFSTRUCTS".

7.1.2 Data type definitions

A data type determines a relation between values and encoding for data of that type. Names are assigned to data types in their type definitions. The syntax of data and data type definitions is as follows (see /EN61131-3/).

data_definition	::= type_name data_name
type_definition	::= constructor type_name
constructor	::= compound_constructor basic_constructor
compound_constructor	::= array_constructor structure_constructor
array_constructor	::= 'ARRAY' '[' length ']' 'OF' type_name
structure_constructor	::= 'STRUCT' 'OF' component_list
component_list	::= component { ',' component }
component	::= type_name component_name
basic_constructor	::= 'BOOLEAN' 'VOID' bit_size 'INTEGER' bit_size 'UNSIGNED' bit_size 'REAL32' 'REAL64' 'NIL'
bit_size	::= '1' '2' <...> '64'
length	::= positive_integer
data_name	::= symbolic_name
type_name	::= symbolic_name
component_name	::= symbolic_name
symbolic_name	::= letter { ['_'] (letter digit) }
positive_integer	::= ('1' '2' <...> '9') { digit }
letter	::= 'A' 'B' <...> 'Z' 'a' 'b' <...> 'z'
digit	::= '0' '1' <...> '9'

Recursive definitions shall not be used.

The data type defined by type_definition is called basic (res.~compound) when the constructor is basic_constructor (res. compound_constructor).

7.1.3 Bit sequences

7.1.3.1 Definition of bit sequences

A bit shall take the values 0 or 1. A bit sequence b is an ordered set of 0 or more bits. If a bit sequence b contains more than 0 bits, they are denoted as b_j , $j \geq 0$. Let b_0, \dots, b_{n-1} be bits, n a positive integer. Then

$$b = b_0 b_1 \dots b_{n-1}$$

is called a bit sequence of length $|b| = n$. The empty bit sequence of length 0 is denoted ε .

Examples: 10110100_b, 1_b, 101_b, etc. are bit sequences.

The inversion operator (\neg) on bit sequences assigns to a bit sequence

$$b = b_0 b_1 \dots b_{n-1}$$

the bit sequence

$$\neg b = \neg b_0 \neg b_1 \dots \neg b_{n-1}$$

Here $\neg 0 = 1$ and $\neg 1 = 0$ on bits.

The basic operation on bit sequences is concatenation.

Let $a = a_0 \dots a_{m-1}$ and $b = b_0 \dots b_{n-1}$ be bit sequences. Then the concatenation of a and b , denoted ab , is

$$ab = a_0 \dots a_{m-1} b_0 \dots b_{n-1}$$

Example: (10)(111) = 10111 is the concatenation of 10 and 111.

The following holds for arbitrary bit sequences a and b :

$$|ab| = |a| + |b|$$

and

$$\varepsilon a = a \varepsilon = a$$

7.1.3.2 Transfer syntax for bit sequences

For transmission across the network a bit sequence is reordered into a sequence of octets. Here and in the following hexadecimal notation is used for octets. Let $b = b_0 \dots b_{n-1}$ be a bit sequence with $n \leq 64$. Denote k a non-negative integer such that $8(k-1) < n \leq 8k$. Then b is transferred in k octets assembled as specified in Figure 12. The bits b_i , $i \geq n$ of the highest numbered octet are "do not care" bits.

Octet 1 is transmitted first and octet k is transmitted last. Hence the bit sequence is transferred as follows across the network:

$$b_7, b_6, \dots, b_0, b_{15}, \dots, b_8, \dots$$

octet number	1.	2.	k.
	b7 .. b0	b15 .. b8	b8k-1 .. b8k-8

Figure 12: Transfer syntax for bit sequences

Example:

$$\begin{array}{rcc}
 \text{Bit 9} & \dots & \text{Bit 0} \\
 10_b & 0001_b & 1100_b \\
 2_h & 1_h & C_h \\
 & & = 21C_h
 \end{array}$$

The bit sequence $b = b_9 \dots b_0 = 0011\ 1000\ 01_b$ represents an `UNSIGNED10` with the value $21C_h$ and is transferred in two octets:

First $1C_h$ and then 02_h .

7.1.4 Basic data types

7.1.4.1 General

For basic data types “type_name” equals the literal string of the associated constructor (aka *symbolic_name*), e.g.,

`BOOLEAN BOOLEAN`

is the type definition for the `BOOLEAN` data type.

7.1.4.2 NIL

Data of basic data type `NIL` is represented by ϵ .

7.1.4.3 Boolean

Data of basic data type `BOOLEAN` attains the values `TRUE` or `FALSE`. The values are represented as bit sequences of length 1. The value `TRUE` (res. `FALSE`) is represented by the bit sequence 1 (res. 0).

7.1.4.4 Void

Data of basic data type `VOIDn` is represented as bit sequences of length n bit. The value of data of type `VOIDn` is undefined. The bits in the sequence of data of type `VOIDn` shall either be specified explicitly or else marked “do not care”.

Data of type `VOIDn` is useful for reserved fields and for aligning components of compound values on octet boundaries.

7.1.4.5 Unsigned Integer

Data of basic data type `UNSIGNEDn` has values in the non-negative integers. The value range is 0, ..., 2^n-1 . The data is represented as bit sequences of length n . The bit sequence

$$b = b_0 \dots b_{n-1}$$

is assigned the value

$$\text{UNSIGNEDn}(b) = b_{n-1} 2^{n-1} + \dots + b_1 2^1 + b_0 2^0$$

Note that the bit sequence starts on the left with the least significant byte.

Example: The value $266 = 10A_h$ with data type `UNSIGNED16` is transferred in two octets across the bus, first $0A_h$ and then 01_h .

The UNSIGNEDn data types transferred are defined in Figure 13.

octet number	1.	2.	3.	4.	5.	6.	7.	8.
UNSIGNED8	b7..b0							
UNSIGNED16	b7..b0	b15..b8						
UNSIGNED24	b7..b0	b15..b8	b23..b16					
UNSIGNED32	b7..b0	b15..b8	b23..b16	b31..b24				
UNSIGNED40	b7..b0	b15..b8	b23..b16	b31..b24	b39..b32			
UNSIGNED48	b7..b0	b15..b8	b23..b16	b31..b24	b39..b32	b47..b40		
UNSIGNED56	b7..b0	b15..b8	b23..b16	b31..b24	b39..b32	b47..b40	b55..b48	
UNSIGNED64	b7..b0	b15..b8	b23..b16	b31..b24	b39..b32	b47..b40	b55..b48	b63..b56

Figure 13: Transfer syntax for data type UNSIGNEDn

7.1.4.6 Signed Integer

Data of basic data type INTEGERn has values in the integers. The value range is from -2^{n-1} to $2^{n-1}-1$. The data is represented as bit sequences of length n . The bit sequence

$$b = b_0 \dots b_{n-1}$$

is assigned the value

$$\text{INTEGERn}(b) = b_{n-2} 2^{n-2} + \dots + b_1 2^1 + b_0 2^0 \quad \text{if } b_{n-1} = 0$$

and, performing two's complement arithmetic,

$$\text{INTEGERn}(b) = -\text{INTEGERn}(\text{^}b) - 1 \quad \text{if } b_{n-1} = 1$$

Note that the bit sequence starts on the left with the least significant bit.

Example: The value $-266 = \text{FEF6}_h$ with data type INTEGER16 is transferred in two octets across the bus, first F6_h and then FE_h .

The INTEGERn data types transferred are defined in Figure 14.

octet number	1.	2.	3.	4.	5.	6.	7.	8.
INTEGER8	b7..b0							
INTEGER16	b7..b0	b15..b8						
INTEGER24	b7..b0	b15..b8	b23..b16					
INTEGER32	b7..b0	b15..b8	b23..b16	b31..b24				
INTEGER40	b7..b0	b15..b8	b23..b16	b31..b24	b39..b32			
INTEGER48	b7..b0	b15..b8	b23..b16	b31..b24	b39..b32	b47..b40		
INTEGER56	b7..b0	b15..b8	b23..b16	b31..b24	b39..b32	b47..b40	b55..b48	
INTEGER64	b7..b0	b15..b8	b23..b16	b31..b24	b39..b32	b47..b40	b55..b48	b63..b56

Figure 14: Transfer syntax for data type INTEGERn

7.1.4.7 Floating-Point Numbers

Data of basic data types REAL32 and REAL64 have values in the real numbers.

The data type REAL32 is represented as bit sequence of length 32. The encoding of values follows /IEEE754/. The transfer syntax is specified in Figure 15.

The data type REAL64 is represented as bit sequence of length 64. The encoding of values follows /IEEE754/.

A bit sequence of length 32 either has a value (finite non-zero real number, ± 0 , $\pm _$) or is NaN (not-a-number). The bit sequence

$$b = b_0 \dots b_{31}$$

is assigned the value (finite non-zero number)

$$\text{REAL32}(b) = (-1)^S 2^{E-127} (1 + F)$$

Here

$S = b_{31}$ is the sign.

$E = b_{30} 2^7 + \dots + b_{23} 2^0$, $0 < E < 255$, is the un-biased exponent.

$F = 2^{-23} (b_{22} 2^{22} + \dots + b_1 2^1 + b_0 2^0)$ is the fractional part of the number.

$E = 0$ is used to represent ± 0 . $E = 255$ is used to represent infinities and NaN's.

Note that the bit sequence starts on the left with the least significant bit.

Example:

$$6,25 = 2^E - 127 (1 + F) \text{ with}$$

$$E = 129 = 2^7 + 2^0 \text{ and}$$

$$F = 2^{-1} + 2^{-4} = 2^{-23} (2^{22} + 2^{19}) \text{ hence the number is represented as:}$$

S	E	F
b_{31}	$b_{30} \dots b_{23}$	$b_{22} \dots b_0$
0	100 0000 1 _b	100 1000 0000 0000 0000 0000 _b

$$6,25 = b_0 \dots b_{31} = 0000\ 0000\ 0000\ 0000\ 0001\ 0011\ 0000\ 0010_b$$

It is transferred in the following order:

octet number	1.	2.	3.	4.
REAL32	00 _h	00 _h	C8 _h	40 _h
	b7..b0	b15..b8	b23..b16	b31..b24

Figure 15: Transfer syntax of data type REAL32

7.1.5 Compound data types

Type definitions of compound data types expand to a unique list of type definitions involving only basic data types. Correspondingly, data of compound type 'type_name' are ordered lists of component data named 'component_name_i' of basic type 'basic_type_i'.

Compound data types constructors are ARRAY and STRUCT OF.

STRUCT OF

basic_type_1 component_name_1,

basic_type_2 component_name_2,

...

basic_type_N component_name_N

type_name

ARRAY [length] OF basic_type type_name

The bit sequence representing data of compound type is obtained by concatenating the bit sequences representing the component data.

Assume that the components '*component_name_i*' are represented by their bit sequences

$$b(i), \text{ for } i = 1, \dots, N$$

Then the compound data is represented by the concatenated sequence

$$b_0(1) \dots b_{n-1}(1) \dots b_{n-1}(N).$$

Example:

Consider the data type

```
STRUCT OF
  INTEGER10      x,
  UNSIGNED5      u
NewData
```

Assume $x = -423 = 259_h$ and $u = 30 = 1E_h$. Let $b(x)$ and $b(u)$ denote the bit sequences representing the values of x and u , respectively. Then:

$$\begin{aligned} b(x) &= b_0(x) \dots b_9(x) &= 1001101001_b \\ b(u) &= b_0(u) \dots b_4(u) &= 01111_b \\ b(xu) = b(x) b(u) &= b_0(xu) \dots b_{14}(xu) &= 1001101001 01111_b \end{aligned}$$

The value of the structure is transferred with two octets, first 59_h and then $7A_h$.

7.1.6 Extended data types

7.1.6.1 General

The extended data types consist of the basic data types and the compound data types defined in the following subsections.

7.1.6.2 Octet String

The data type OCTET_STRING $length$ is defined below; $length$ is the length of the octet string.

```
ARRAY [ length ] OF UNSIGNED8 OCTET_STRINGlength
```

7.1.6.3 Visible String

The data type VISIBLE_STRING $length$ is defined below. The admissible values of data of type VISIBLE_CHAR are 0_h and the range from 20_h to $7E_h$. The data are interpreted as ISO 646-1973(E) 7-bit coded characters. $length$ is the length of the visible string.

```
UNSIGNED8          VISIBLE_CHAR
ARRAY [ length ] OF VISIBLE_CHAR  VISIBLE_STRINGlength
```

There is no 0_h necessary to terminate the string.

7.1.6.4 Unicode String

The data type UNICODE_STRING $length$ is defined below; $length$ is the length of the unicode string.

```
ARRAY [ length ] OF UNSIGNED16      UNICODE_STRINGlength
```

7.1.6.5 Time of Day

The data type TIME_OF_DAY represents absolute time. It follows from the definition and the encoding rules that TIME_OF_DAY is represented as bit sequence of length 48.

Component ms is the time in milliseconds after midnight. Component $days$ is the number of days since January 1, 1984.

```
STRUCT OF
  UNSIGNED28  ms,
  VOID4       reserved,
  UNSIGNED16  days
TIME_OF_DAY
```

7.1.6.6 Time Difference

The data type TIME_DIFFERENCE represents a time difference. It follows from the definition and the encoding rules that TIME_DIFFERENCE is represented as bit sequence of length 48.

Time differences are sums of numbers of days and milliseconds. Component ms is the number milliseconds. Component days is the number of days.

```
STRUCT OF
    UNSIGNED28 ms,
    VOID4      reserved,
    UNSIGNED16 days
TIME_DIFFERENCE
```

7.1.6.7 Domain

Domains are used to transfer an arbitrary large block of data from a client to a server and vice versa. The content of a data block is application specific and does not fall within the scope of this specification.

7.2 Communication objects

7.2.1 General

The communication objects are described by the services and protocols.

All services are described in a tabular form that contains the parameters of each service primitive that is defined for that service. The primitives that are defined for a particular service determine the service type (e.g. unconfirmed, confirmed, etc.).

All services assume that no failures occur in the data link layer and physical layer of CAN. These failures are resolved by the application and fall not in the scope of this specification.

7.2.2 Process data object (PDO)

7.2.2.1 General

The real-time data transfer is performed by means of "Process Data Objects (PDO)". The transfer of PDO is performed with no protocol overhead.

The PDO correspond to objects in the object dictionary and provide the interface to the application objects. Data type and mapping of application objects into a PDO is determined by a corresponding default PDO mapping structure within the object dictionary. If variable PDO mapping is supported the number of PDO and the mapping of application objects into a PDO may be transmitted to a CANopen device during the configuration process (see clause 7.3.1) by applying the SDO services to the corresponding objects of the object dictionary.

Number and length of PDO of a CANopen device is application specific and may be specified within the device profile or application profile.

There are two kinds of use for PDO. The first is data transmission and the second data reception. It is distinguished in Transmit-PDO (TPDO) and Receive-PDO (RPDO). CANopen devices supporting TPDO are PDO producer and CANopen devices supporting RPDO are called PDO consumer. PDO are described by the PDO communication parameter and the PDO mapping parameter. The structure of these data types is explained in clause 7.4.8. The PDO communication parameter describes the communication capabilities of the PDO. The PDO mapping parameter contains information about the contents of the PDO.

For each PDO the pair of communication and mapping parameter is mandatory. The objects introduced above are described in clause 7.4.

The definition of PDO within a device profile always refers to the 1st logical device within a CANopen device. If the definitions are used for the 2nd logical device the PDO number in the CANopen device used shall be the PDO number as defined in the device profile increased by the value of 64 (40_h) as defined in Table 3.

NOTE: The number of PDOs is not limited for a logical device, for example a CANopen device with only one logical device may have 512 PDOs.

Table 3: Example PDO number calculation

Logical device in CANopen device	PDO number in CANopen device	PDO number in device profile
1 st logical device	PDO number + 0 (PDO1 to PDO64)	PDO number (PDO1 to PDO64)
2 nd logical device	PDO number + 64 (PDO65 to PDO128)	PDO number (PDO1 to PDO64)
3 rd logical device	PDO number + 128 (PDO129 to PDO192)	PDO number (PDO1 to PDO64)
4 th logical device	PDO number + 192 (PDO193 to PDO256)	PDO number (PDO1 to PDO64)
5 th logical device	PDO number + 256 (PDO257 to PDO320)	PDO number (PDO1 to PDO64)
6 th logical device	PDO number + 320 (PDO321 to PDO384)	PDO number (PDO1 to PDO64)
7 th logical device	PDO number + 384 (PDO385 to PDO448)	PDO number (PDO1 to PDO64)
8 th logical device	PDO number + 448 (PDO449 to PDO512)	PDO number (PDO1 to PDO64)

7.2.2.2 Transmission modes

The following PDO transmission modes are distinguished:

- Synchronous transmission
- Event-driven transmission

In order to synchronize CANopen devices a synchronization object (SYNC object) is transmitted periodically by a synchronization application. The SYNC object is represented by a pre-defined communication object (see sub-clause 7.2.5). In Figure 16 the principle of synchronous and event-driven transmission is shown. Synchronous PDOs are transmitted within a pre-defined time-window immediately after the SYNC object.

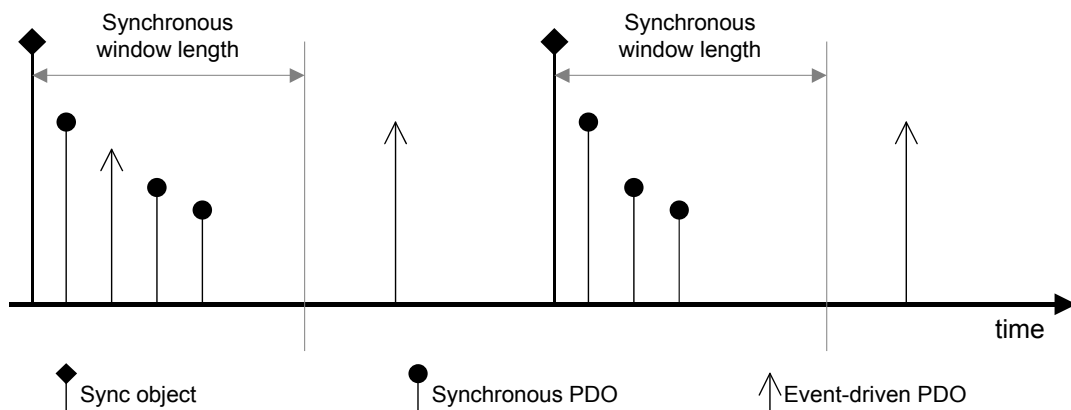

Figure 16: Synchronous and event-driven transmission

The transmission type parameter of a PDO specifies the transmission mode as well as the triggering mode.

For synchronous TPDOs the transmission type also specifies the transmission rate in form of a factor based on the basic SYNC object transmission period. A transmission type of 0 means that the message shall be transmitted after occurrence of the SYNC but acyclic (not periodically), only if an event occurred before the SYNC. The transmission type 1 means that the message shall be transmitted with every SYNC object. A transmission type of n means that the message shall be transmitted with every n -th SYNC object. Event-driven TPDOs are transmitted without any relation to the SYNC object.

The data of synchronous RPDOs received after the occurrence of the SYNC object is passed to the application with the occurrence of the following SYNC, independent of the transmission rate specified by the transmission type. The data of event-driven RPDOs is passed directly to the application.

7.2.2.3 Triggering modes

Three message-triggering modes are distinguished:

- **Event- and timer-driven**

Message transmission is either triggered by the occurrence of an application-specific event specified in the device profile, application profile or manufacturer-specific, or if a specified time (event-time) has elapsed without occurrence of an event.

- **Remotely requested**

The transmission of an event-driven PDO is initiated on receipt of a RTR initiated by a PDO consumer.

- **Synchronously triggered**

Message transmission is triggered by the occurrence of the SYNC object. The trigger condition is the number of Sync and optionally an internal event.

7.2.2.4 PDO services

7.2.2.4.1 General

PDO transmission follows the producer/consumer relationship as described in sub-clause 4.4.4.

Attributes:

- PDO number: PDO number [1..512] for every user type on the local device
- user type: one of the values {consumer, producer}
- data type: according to the PDO mapping
- inhibit-time: $n \cdot 100 \mu\text{s}$, $n \geq 0$

7.2.2.4.2 Service PDO write

The service PDO write is according to the push model. There are zero or more consumers of the PDO. The PDO shall have exactly one producer.

Through this service the producer of the PDO sends the data of the mapped application objects to the consumer(s). The parameters for this service are defined in Table 4.

Table 4: Service PDO write

<i>Parameter</i>	<i>Request / Indication</i>
Argument	Mandatory
PDO number	mandatory
Data	mandatory

7.2.2.4.3 Service PDO read

The service PDO read is according to the pull model. There are one or more consumers of the PDO. The PDO shall have exactly one producer.

Through this service the consumer of the PDO requests the producer to supply the data of the mapped application objects. The service is confirmed. The remote result parameter will confirm the value. The parameters for this service are defined in Table 5.

Table 5: Service PDO read

<i>Parameter</i>	<i>Request / Indication</i>	<i>Response / Confirm</i>
Argument PDO number	Mandatory mandatory	
Remote result Data		Mandatory mandatory

7.2.2.5 PDO protocol

7.2.2.5.1 Protocol PDO write

The request for the service PDO write is unconfirmed. The PDO producer shall send the process data within a PDO to the network. There may be 0 to n PDO consumers. At the PDO consumer(s) the reception of a valid PDO is indicated. Figure 17 defines the PDO write protocol.

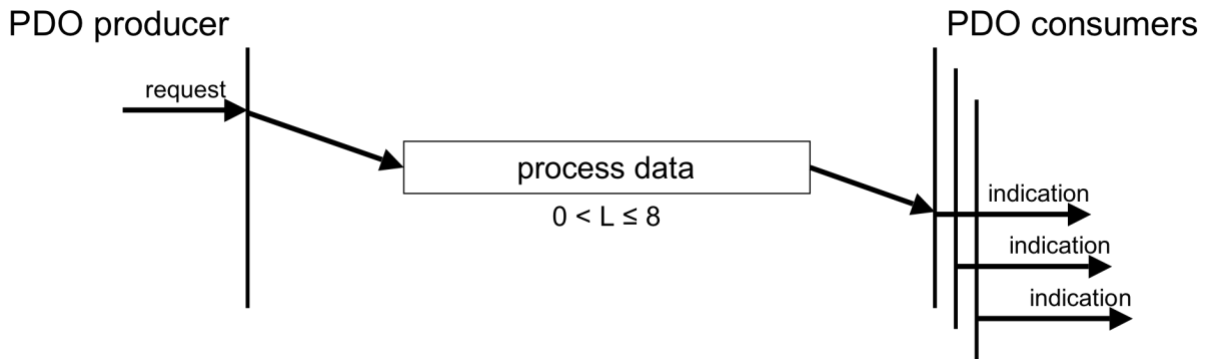

Process data: L bytes of application data

Figure 17: Protocol PDO write

7.2.2.5.2 Protocol PDO read

The service for a PDO read request is confirmed. One or more PDO consumer shall transmit a RTR to the network. At the reception of the RTR the PDO producer for the requested PDO shall transmit the PDO. At all PDO consumers for this PDO the reception shall be indicated. There may be 1 to n PDO consumers. The read service is optional and depends on the hardware capabilities. Figure 18 specifies the PDO read protocol.

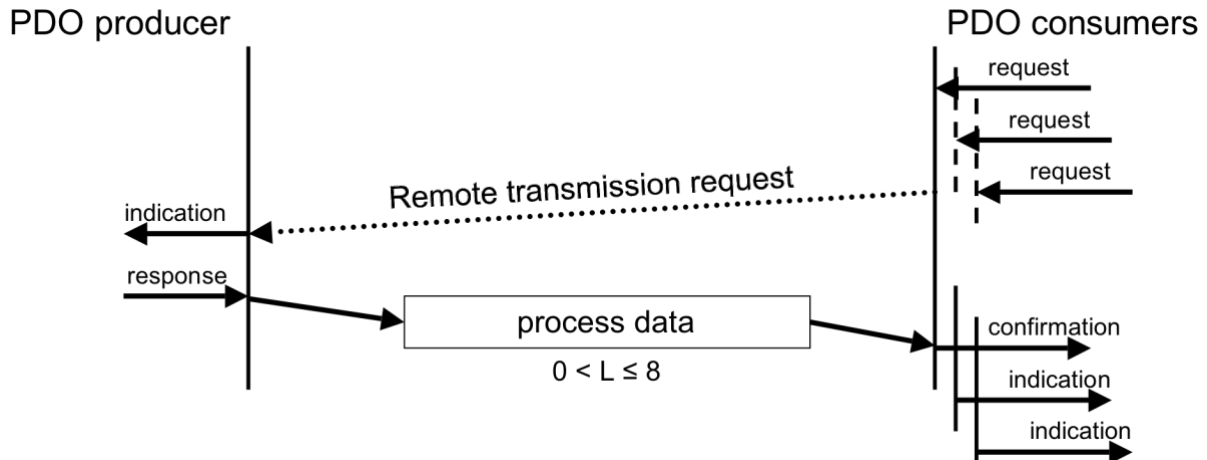

Process data: L bytes of application data

Figure 18: Protocol PDO read

7.2.3 Multiplex PDO (MPDO)

7.2.3.1 General

An MPDO provides direct write access to objects of a CANopen device's object dictionary. The size of the data of these objects is limited to a maximum of 4 bytes.

There are two kinds of use for the MPDO. The first is the destination address mode (DAM) MPDO and the second is the source address mode (SAM) MPDO. CANopen devices supporting to receipt MPDOs are MPDO consumers and CANopen devices supporting to transmit MPDOs are MPDO producers.

The MPDOs correspond to objects in the object dictionary and provide the interface to the application objects.

7.2.3.2 MPDO address modes

7.2.3.2.1 Destination address mode (DAM)

A multiplexer (see 7.2.3.4.1) identifies the object in the MPDO consumer's object dictionary. A DAM-MPDO may be received either by all consumers of this MPDO simultaneously or by a single consumer. Since the used write service is unconfirmed, an EMCY message is generated if the object does not exist.

The transmission of an MPDO at the MPDO producer shall be event-driven and shall not be timer-driven, remotely requested, synchronously triggered.

7.2.3.2.2 Source address mode (SAM)

A multiplexer of the MPDO refer to the MPDO producer. Only one MPDO producer of this type is allowed for each CANopen device. The transmission shall be event-driven and shall not be timer-driven, remotely requested, synchronously triggered. The MPDO producer may use a scanner list in order to know which object shall be send. The MPDO consumers may use a dispatcher list in order to know which source multiplexer references to what destination multiplexer.

7.2.3.3 MPDO service

7.2.3.3.1 General

MPDO transmission follows the producer/consumer relationship as described in sub-clause 4.4.4.

Attributes:

- PDO number: PDO number [1..512] for every user type on the local device
- user type: one of the values {consumer, producer}
- multiplexer: containing index and sub-index of type STRUCTURE OF UNSIGNED16, UNSIGNED8, with index specifying an object of the CANopen device's object dictionary and sub-index specifying a component of a CANopen device's object dictionary object
- address type: one of the values {source, destination}
- Node-ID of the consumer or producer
- inhibit-time: $n * 100 \mu\text{s}$, $n \geq 0$

7.2.3.3.2 Service MPDO write

The service MPDO write is according to the push model. There are zero or more consumers of the MPDO. The MPDO shall have exactly one producer.

The parameters for this service are defined in Table 6.

Table 6: Service MPDO write

<i>Parameter</i>	<i>Request / Indication</i>
Argument	Mandatory
PDO number	mandatory
Address type	mandatory
Node-ID	mandatory
Multiplexer	mandatory
Data	mandatory

7.2.3.4 MPDO protocol

7.2.3.4.1 Protocol MPDO write

The request for the service MPDO write is unconfirmed. The MPDO producer shall send the process data within a MPDO to the network. There may be 0 to n MPDO consumers, depending on the given node-ID. At the MPDO consumer(s) the reception of a valid PDO shall be indicated. Figure 19 specifies the MPDO write protocol.

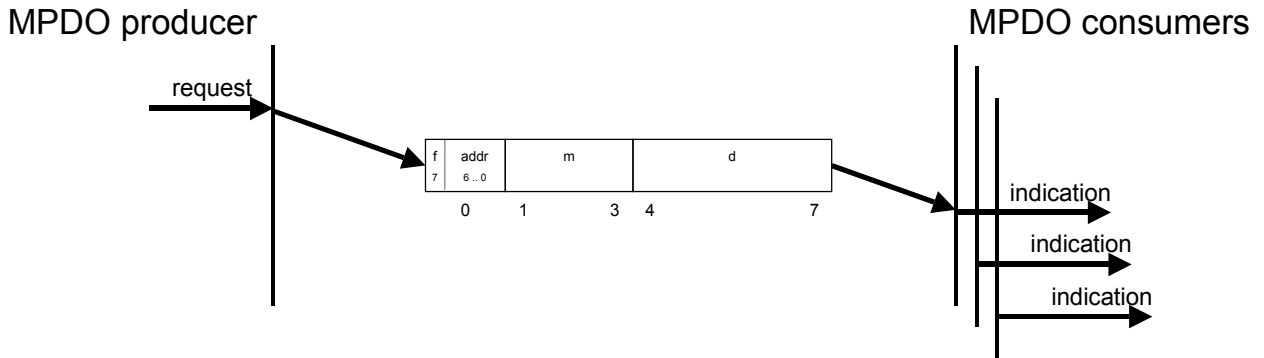

- **f:** address type
 - 0: Source addressing
 - 1: Destination addressing
- **addr:** node-ID of the MPDO consumer in destination addressing or MPDO producer in source addressing.
 - 0: Shall be reserved in source addressing mode. Shall address all CANopen devices in the network that are configured for MPDO reception in destination addressing mode.
 - 1..127: Shall address the CANopen device in the network with the very same node-ID.
- **m:** multiplexer. It represents the index/sub-index of the process data to be transferred by the MPDO. Depending on the address type the index/sub-index shall be used to identify the data from the transmitting CANopen device (source addressing) or to identify the data on the receiving CANopen device (destination addressing).
- **d:** process data. Data length lower than 4 bytes is filled up to fit 32-bit.

Figure 19: Protocol MPDO write

7.2.4 Service data object (SDO)

7.2.4.1 General

A SDO is providing direct access to object entries of a CANopen device's object dictionary. As these object entries may contain data of arbitrary size and data type. SDOs may be used to transfer multiple data sets (each containing an arbitrary large block of data) from a client to a server and vice versa. The client shall control via a multiplexer (index and sub-index of the object dictionary) which data set shall be transferred. The content of the data set is defined within the object dictionary.

Basically an SDO is transferred as a sequence of segments. Prior to transferring the segments there is an initialization phase where client and server prepare themselves for transferring the segments. For SDOs, it is also possible to transfer a data set of up to four bytes during the initialization phase. This mechanism is called SDO expedited transfer.

Optionally an SDO may be transferred as a sequence of blocks where each block may consist of a sequence of up to 127 segments containing a sequence number and the data. Prior to transferring the blocks there shall be an initialization phase where client and server may prepare themselves for transferring the blocks and negotiating the number of segments in one block. After transferring the blocks there shall be a finalization phase where client and server may verify the correctness of the previous data transfer by comparing checksums derived from the data set. The transfer type mentioned above is called SDO block transfer, which is faster than the segmented transfer for a large set of data.

In SDO block upload it is possible that the size of the data set does not justify the use of a block transfer because of the implied protocol overhead. In these cases a support for a fallback to the SDO normal (segmented) or SDO expedited transfer in initialization phase may be implemented. As the assumption of the minimal data set size for which an SDO block transfer outperforms the other transfer types depends on various parameters the client indicates this threshold value in bytes to the server in initialization phase.

For the SDO block transfer a Go-Back-n ARQ scheme is used to confirm each block:

- After SDO block download the server indicates the client the last successfully received segment of this SDO block transfer by acknowledging this segment sequence number. Doing this the server implicitly acknowledges all segments preceding this segment. The client shall start the following

SDO block transfer with the retransmission of all not acknowledged data. Additionally the server shall indicate the number of segments per SDO block for the next SDO block transfer.

- After SDO block upload the client indicates the server the last successfully received segment of the SDO block transfer by acknowledging this segment sequence number. Doing this the client implicitly acknowledges all segments preceding this segment. The server shall start the following SDO block transfer with the retransmission of all not acknowledged data. Additionally the client shall indicate the number of segments per SDO block for the next SDO block transfer.

Always the client initiates an SDO transfer for any type of transfer. The owner of the accessed object dictionary is the server of the SDO. Either the client or the server may take the initiative to abort the transfer of an SDO.

By means of an SDO a peer-to-peer communication channel between two CANopen devices is established. A CANopen device may support more than one SDO. One supported Server-SDO is the default case (Default SDO).

SDOs are described by the SDO communication parameter record. The structure of this data type is explained in sub-clause 7.4.8. The SDO communication parameter describes the communication capabilities of the SDO and CSDO.

For each SDO the communication parameters are mandatory. If only one SDO exist the communication parameters may be omitted. The objects mentioned above are described in sub-clause 7.4.

7.2.4.2 SDO services

7.2.4.2.1 General

The model for the SDO communication is the Client/Server model as described in sub-clause 4.4.3.

Attributes:

- SDO number: SDO number [1..128] for every user type on the local device
- user type: one of the values {client, server}
- mux data type: multiplexer containing index and sub-index of type STRUCTURE OF UNSIGNED16, UNSIGNED8, with index specifying an object of the CANopen device's object dictionary and sub-index specifying a component of a CANopen device's object dictionary object
- transfer type: depends on the length of data to transfer: expedited, normal (segmented) or block for up to 4 data bytes; normal (segmented) or block for more than 4 data bytes
- data type: according to the referenced index and sub-index

The following services may be applied onto an SDO depending on the application requirements:

- SDO download, which is subdivided into
 - SDO download initiate
 - SDO download segment
- SDO upload, which is subdivided into
 - SDO upload initiate
 - SDO upload segment
- SDO abort transfer

When using the SDO normal (segmented) download and SDO normal (segmented) upload services, the communication software will be responsible for transferring the SDO as a sequence of segments.

SDO expedited transfer shall be supported. SDO segmented transfer shall be supported if objects larger than 4 Bytes are supported. Optionally the following SDO services for doing an SDO block transfer with higher bus utilization and performance for a large data set size may be implemented:

- SDO block download, which is subdivided into
 - SDO block download initiate
 - SDO block download block
 - SDO block download end

- SDO block upload, which is subdivided into
 - SDO block upload initiate
 - SDO block upload block
 - SDO block upload end

When using the SDO block download and SDO block upload services, the communication software will be responsible for transferring the data as a sequence of blocks.

In SDO block upload protocol a support for a switch to SDO upload protocol in SDO block upload initiate may be implemented to increase transfer performance for data which size does not justify using the protocol overhead of the SDO block upload protocol.

To abort an SDO block transfer the SDO abort transfer service is used.

7.2.4.2.2 Service SDO download

The client is using the service SDO download for transferring data from the client to the server (owner of the object dictionary). The data, the multiplexer (index and sub-index) of the data set, and its size are indicated to the server. The parameters for this service are defined in Table 7.

The service is confirmed. The remote result parameter will indicate the success or failure of the request. In case of a failure, optionally the reason is confirmed.

The SDO download consists of at least the SDO download initiate service and optionally of the SDO download segment services (data length > 4 bytes).

Table 7: Service SDO download

<i>Parameter</i>	<i>Request / Indication</i>	<i>Response / Confirm</i>
Argument	Mandatory	
SDO number	mandatory	
Multiplexer	mandatory	
Size	optional	
Data	mandatory	
Remote result		Mandatory
Success		selection
Failure		selection
Reason		optional

7.2.4.2.3 Service SDO download initiate

The client requests the server to prepare downloading of data by using the SDO download initiate service. Optionally the size of the data to be downloaded is indicated to the server. The parameters for this service are defined in Table 8.

The multiplexer of the data set and the transfer type are indicated to the server. In case of an SDO expedited download, the data of the data set identified by the multiplexer and size is indicated to the server.

Table 8: Service SDO download initiate

<i>Parameter</i>	<i>Request / Indication</i>	<i>Response / Confirm</i>
Argument	Mandatory	
SDO number	mandatory	
Multiplexer	mandatory	
Transfer type	mandatory	
Normal	selection	
Expedited	selection	
Size	optional	
Data	mandatory	
Remote result		Mandatory
Success		mandatory

The service is confirmed. The remote result parameter will indicate the success of the request. In case of a failure, an SDO abort transfer request shall be initiated. In the case of a successful SDO expedited download of a multiplexed DOMAIN, this service concludes the download of the data set identified by multiplexer.

7.2.4.2.4 Service SDO download segment

The client transfers the segmented data to the server by using the SDO download service. The segment data and optionally its size are indicated to the server. The continue parameter indicates the server whether there are still more segments to be downloaded or that this was the last segment to be downloaded. The parameters for this service are defined in Table 9.

Table 9: Service SDO download segment

<i>Parameter</i>	<i>Request / Indication</i>	<i>Response / Confirm</i>
Argument	Mandatory	
SDO number	mandatory	
Continue	mandatory	
More	selection	
Last	selection	
Size	mandatory	
Data	mandatory	
Remote result		Mandatory
Success		mandatory

The service is confirmed. The remote result parameter will indicate the success of the request. In case of a failure, an SDO abort transfer request shall be initiated. In case of success, the server has accepted the segment data and is ready to accept the next segment. There shall be at most one SDO download segment service outstanding for an SDO transfer.

A successful SDO download initiate service with segmented transfer type shall have been executed prior to this service.

7.2.4.2.5 Service SDO upload

The client is using the service SDO upload for transferring the data from the server (owner of the object dictionary) to the client. The multiplexer (index and sub-index) of the data set is indicated to the server. The parameters for this service are defined in Table 10.

The SDO upload consists of at least the SDO upload initiate service and optional of SDO upload segment services (data length > 4 bytes).

Table 10: Service SDO upload

<i>Parameter</i>	<i>Request / Indication</i>	<i>Response / Confirm</i>
Argument	Mandatory	
SDO number	mandatory	
Multiplexer	mandatory	
Remote result		Mandatory
Success		selection
Size		optional
Data		mandatory
Failure		selection
Reason		optional

The service is confirmed. The remote result parameter will indicate the success or failure of the request. In case of a failure, optionally the reason is confirmed. In case of success, the data and its size are confirmed.

7.2.4.2.6 Service SDO upload initiate

The client requests the server to prepare the data for uploading by using the SDO upload initiate service. The multiplexer (index and sub-index) of the data set whose upload is initiated is indicated to the server. The parameters for this service are defined in Table 11.

The service is confirmed. The remote result parameter will indicate the success of the request. In case of a failure, an SDO abort transfer request shall be executed. In the case of success, the size of the data is confirmed. In case of successful SDO expedited upload, this service concludes the upload of the data set identified by multiplexer and the corresponding data is confirmed.

Table 11: Service SDO upload initiate

<i>Parameter</i>	<i>Request / Indication</i>	<i>Response / Confirm</i>
Argument	Mandatory	
SDO number	mandatory	
Multiplexer	mandatory	
Remote result		Mandatory
Success		mandatory
Multiplexer		mandatory
Transfer type		mandatory
Normal		selection
Expedited		selection
Size		optional
Data		mandatory

7.2.4.2.7 Service SDO upload segment

The client requests the server to supply the data of the next segment by using the SDO upload segment service. The continue parameter indicates the client whether there are still more segments to be uploaded or that this was the last segment to be uploaded. There shall be at most one SDO upload segment service outstanding for an SDO. The parameters for this service are defined in Table 12.

The service is confirmed. The remote result parameter will indicate the success of the request. In case of a failure, an SDO abort transfer request shall be initiated. In case of success, the segment data and optionally its size are confirmed.

A successful SDO upload initiate service with normal (segmented) transfer type shall be executed prior to this service.

Table 12: Service SDO upload segment

<i>Parameter</i>	<i>Request / Indication</i>	<i>Response / Confirm</i>
Argument	Mandatory	
SDO number	mandatory	
Remote result		Mandatory
Success		mandatory
Continue		mandatory
More		selection
Last		selection
Size		mandatory
Data		mandatory

7.2.4.2.8 Service SDO block download

The client is using the service SDO block download for transferring the data from the client to the server (owner of the object dictionary). The data, the multiplexer (index and sub-index) of the data set and optionally its size is indicated to the server. The parameters for this service are defined in Table 13.

The service is confirmed. The remote result parameter will indicate the success or failure of the request. In case of a failure, optionally the reason is confirmed.

Table 13: Service SDO block download

<i>Parameter</i>	<i>Request / Indication</i>	<i>Response / Confirm</i>
Argument	Mandatory	
SDO number	mandatory	
Multiplexer	mandatory	
Size	optional	
Data	mandatory	
Remote result		Mandatory
Success		selection
Failure		selection
Reason		optional

7.2.4.2.9 Service SDO block download initiate

The client requests the server to prepare for download by using the SDO block download initiate service. The parameters for this service are defined in Table 14.

The multiplexer of the data set and optionally the size are indicated to the server.

Both the client and the server are indicating their ability and demand to verify the complete transfer with a checksum in SDO block download end.

Table 14: Service SDO block download initiate

<i>Parameter</i>	<i>Request / Indication</i>	<i>Response / Confirm</i>
Argument	Mandatory	
SDO number	mandatory	
CRC ability	mandatory	
yes	selection	
no	selection	
Multiplexer	mandatory	
Size	optional	
Remote result		Mandatory
Success		mandatory
CRC ability		mandatory
yes		selection
no		selection
Blksize		mandatory

The service is confirmed. The remote result parameter will indicate the success of the request, the number of segments per block the server is able to receive and its ability and demand to verify the complete transfer with a checksum. In case of a failure, an SDO abort transfer service shall be initiated.

7.2.4.2.10 Service SDO block download sub-block

The client transfers the data of the next block to the server by using the SDO block download sub-block service. The block data is transferred to the server by a sequence of segments. Each segment consists of the data and a sequence number starting by 1, which is increased for each segment by 1 up to blksize. The parameter blksize is negotiated between server and client in the SDO block download initiate service and may be changed by the server with each confirmation for a block transfer. The continue parameter indicates the server whether to stay in the SDO block download sub-block phase or to change in the SDO block download end phase. The parameters for this service are defined in Table 15.

Table 15: Service SDO block download sub-block

<i>Parameter</i>	<i>Request / Indication</i>	<i>Response / Confirm</i>
Argument	Mandatory	
SDO number	mandatory	
Continue	mandatory	
More	selection	
Last	selection	
Data	mandatory	
Remote result		Mandatory
Success		mandatory
Ackseq		mandatory
Blksize		mandatory

The service is confirmed. The remote result parameter will indicate the success of the request. In case of a success the ackseq parameter indicates the sequence number of the last segment the server has received successfully. If this number does not correspond with the sequence number of the last segment sent by the client during this block transfer the client shall retransmit all segments discarded by the server within the next block transfer. In case of a fatal failure, an SDO abort transfer service shall be initiated. In case of success, the server has accepted all acknowledged segment data and is ready to accept the next block. There shall be at most one SDO block download sub-block service outstanding for an SDO transfer.

A successful SDO block download initiate service shall be executed prior to this service.

7.2.4.2.11 Service SDO block download end

The client indicates the end of the transfer to the server by using the SDO block download end service. The number of bytes not containing valid data in the last transmitted segments is indicated to the server. The parameters for this service are defined in Table 16.

If both the server and the client have indicated their ability and demand to check the complete transfer with a checksum in SDO block download initiate the client indicates the checksum of the transferred data to the server. The server also shall generate the checksum which shall be compared with the one generated by the client.

Table 16: Service SDO block download end

<i>Parameter</i>	<i>Request / Indication</i>	<i>Response / Confirm</i>
Argument SDO number Valid_data Checksum Remote result Success	Mandatory mandatory mandatory conditional, mandatory if negotiated	 Mandatory mandatory

The service is confirmed. The remote result parameter will indicate the success of the request (matching checksums between client and server if negotiated) and concludes the download of the data set. In case of a failure, an SDO abort transfer service shall be initiated.

7.2.4.2.12 Service SDO block upload

The client is using the service SDO block upload to transfer the data from the server (owner of the object dictionary) to the client. The multiplexer (index and sub-index) of the data set requested is indicated to the server. The parameters for this service are defined in Table 17.

The service is confirmed. The remote result parameter will indicate the success or failure of the request. In case of a failure, optionally the reason is confirmed. In case of a success, the data and optionally its size is confirmed.

Table 17: Service SDO block upload

<i>Parameter</i>	<i>Request / Indication</i>	<i>Response / Confirm</i>
Argument SDO number Multiplexer Remote result Success Size Data Failure Reason	Mandatory mandatory mandatory	 Mandatory selection optional mandatory selection optional

7.2.4.2.13 Service SDO block upload initiate

The client requests the server to prepare for uploading data by using the SDO block upload initiate service. The multiplexer of the data set whose upload is initiated and the number of segments the client is able to receive are indicated to the server. The parameters for this service are defined in Table 18.

A protocol switch threshold value is indicated to the server. If the number of bytes that shall be uploaded is less or equal this value the server may confirm this data transfer with the SDO upload service as described in sub-clause 7.2.4.2.5. Both the client and the server are indicating their ability and demand to verify the complete transfer by use of a checksum. Optionally the size of the uploaded data is indicated to the client.

Table 18: Service SDO block upload initiate

<i>Parameter</i>	<i>Request / Indication</i>	<i>Response / Confirm</i>
Argument	Mandatory	
SDO number	mandatory	
Blksize	mandatory	
CRC ability	mandatory	
Yes	selection	
No	selection	
Multiplexer	mandatory	
Threshold	mandatory	
Remote result		Mandatory
Success		mandatory
CRC ability		mandatory
Yes		selection
No		selection
Size		optional

The service is confirmed. In case of a failure, an SDO abort transfer service shall be initiated. In case of success the size of the data is optionally indicated to the client.

7.2.4.2.14 Service SDO block upload sub-block

This service is initiated by the client with the previous SDO upload initiate service or the previous SDO block upload sub-block service. The server transfers the data of the next block to the client by using the SDO block upload sub-block service. The block data is indicated to the client by a sequence of segments. Each segment consists of the segment data and a sequence number starting by 1, which is increased for each segment by 1 up to blksize. The parameter blksize is indicated by the client to the server during the SDO block upload initiate service and may be changed by the client with each confirmation for a block transfer. The continue parameter indicates the client whether to stay in the SDO block upload phase or to change in the SDO block upload end phase. The parameters for this service are defined in Table 19.

Table 19: Service SDO block upload sub-block

<i>Parameter</i>	<i>Request / Indication</i>	<i>Response / Confirm</i>
Argument	Mandatory	
SDO number	mandatory	
Continue	mandatory	
More	selection	
Last	selection	
Data	mandatory	
Remote result		Mandatory
Success		mandatory
Ackseq		mandatory
Blksize		mandatory

The service is confirmed. The remote result parameter will indicate the success of the request. In case of a success the ackseq parameter indicates the sequence number of the last segment the client has received successfully. If this number does not correspond with the sequence number of the last segment sent by the server during this block transfer the server shall retransmit all segments discarded by the client with the next block transfer. In case of a fatal failure, an SDO abort transfer service shall be initiated. In case of success, the client has accepted all acknowledged segment data and is ready to accept the next block. There shall be at most one SDO block upload sub-block service outstanding for an SDO transfer.

A successful SDO block upload initiate service shall be executed prior to this service.

7.2.4.2.15 Service SDO block upload end

The server indicates the end of the transfer to the client by using the SDO block upload end service. The number of bytes not containing valid data in the last transmitted segments is indicated to the client. The parameters for this service are defined in Table 20.

If both the server and the client have indicated their ability and demand to check the complete transfer by using checksum during SDO block upload initiate this checksum is indicated to the client by the server. The client also shall generate the checksum which shall be compared with the one generated by the server.

Table 20: Service SDO block upload end

<i>Parameter</i>	<i>Request / Indication</i>	<i>Response / Confirm</i>
Argument SDO number Valid_data Checksum	Mandatory mandatory mandatory mandatory if negotiated	
Remote result Success		Mandatory mandatory

The service is confirmed. The remote result parameter will indicate the success of the request (matching checksums between client and server if negotiated) and concludes the download of the data set. In case of a failure, an SDO abort transfer service shall be initiated.

7.2.4.2.16 Service SDO abort transfer

The SDO abort transfer service aborts the SDO upload service or SDO download service of an SDO referenced by its number. The reason is indicated. The service is unconfirmed. Both the client and the server of an SDO may execute the service at any time. If the client of an SDO has a confirmed service outstanding, the indication of the abort is taken to be the confirmation of that service. The parameters for this service are defined in Table 21.

Table 21: Service SDO abort transfer

<i>Parameter</i>	<i>Request / Indication</i>
Argument SDO number Multiplexer Reason	Mandatory mandatory mandatory mandatory

7.2.4.3 SDO protocols

7.2.4.3.1 General

Six confirmed services (SDO download, SDO upload, SDO upload initiate, SDO download initiate, SDO download segment, and SDO upload segment) and one unconfirmed service (SDO abort transfer) are defined for SDOs doing the SDO normal (segmented) and SDO expedited transfer.

Eight confirmed services (SDO block download, SDO block upload, SDO block upload initiate, SDO block download initiate, SDO block download sub-block, SDO block upload sub-block, SDO block upload end, and SDO block download end) and one unconfirmed service (SDO abort transfer) are defined for SDOs doing the optional SDO block transfer.

7.2.4.3.2 Protocol SDO download

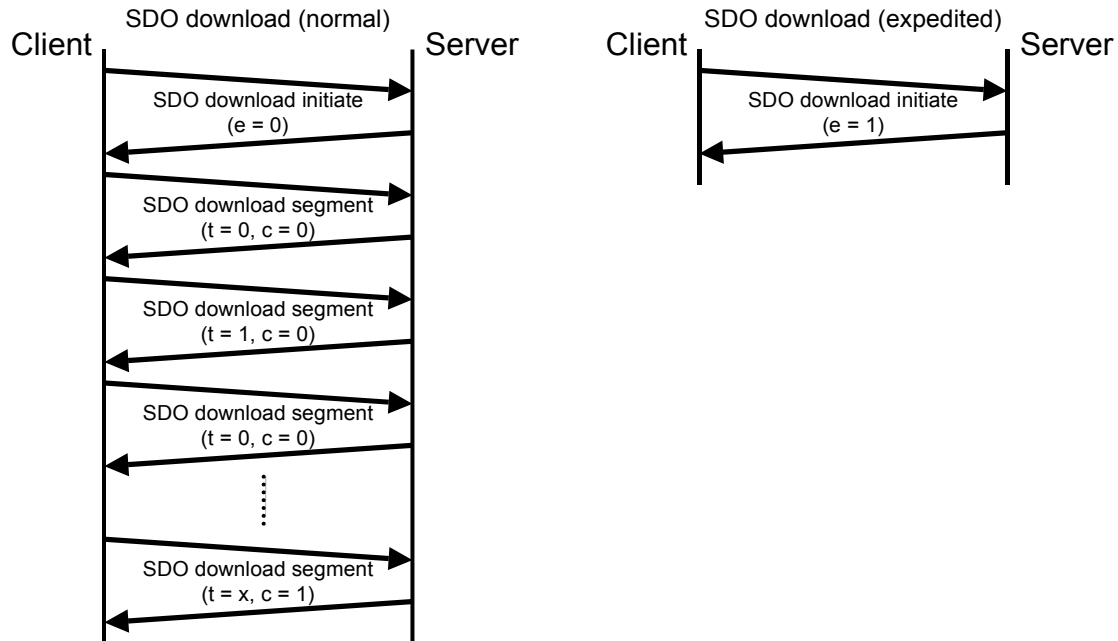

Figure 20: Protocol SDO download

This protocol (specified in Figure 20) shall be used to implement the SDO download service. SDOs are downloaded as a sequence of zero or more SDO download segment services preceded by an SDO download initiate service. The sequence is terminated by:

- An SDO download initiate request/indication with the e-bit set to 1 followed by an SDO download initiate response/confirm, indicating the successful completion of an expedited download sequence.
- An SDO download segment response/confirm with the c-bit set to 1, indicating the successful completion of a normal download sequence.
- An SDO abort transfer request/indication, indicating the unsuccessful completion of the download sequence.
- A new SDO download initiate request/indication, indicating the unsuccessful completion of the download sequence and the start of a new SDO download sequence.

If in the download of two consecutive segments the toggle bit does not alter, the content of the last segment shall be ignored. If such an error is reported to the application, the application may decide to abort the download.

7.2.4.3.3 Protocol SDO download initiate

The protocol as defined in Figure 21 shall be used to implement the SDO download initiate service.

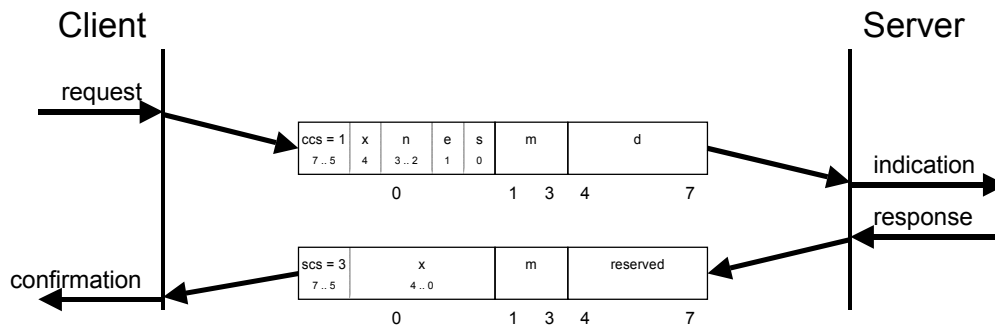

- **ccs: client command specifier**
 - 1: initiate download request
- **scs: server command specifier**
 - 3: initiate download response
- **n:** Only valid if $e = 1$ and $s = 1$, otherwise 0. If valid it indicates the number of bytes in d that do not contain data. Bytes $[8-n, 7]$ do not contain data.
- **e: transfer type**
 - 0: normal transfer
 - 1: expedited transfer
- **s: size indicator**
 - 0: data set size is not indicated
 - 1: data set size is indicated
 - **m:** multiplexer. It represents the index/sub-index of the data to be transfer by the SDO.
- **d: data**
 - $e = 0, s = 0$: d is reserved for further use.
 - $e = 0, s = 1$: d contains the number of bytes to be downloaded.
 - Byte 4 contains the LSB and byte 7 contains the MSB.
 - $e = 1, s = 1$: d contains the data of length $4-n$ to be downloaded,
 - the encoding depends on the type of the data referenced by index and sub-index
 - $e = 1, s = 0$: d contains unspecified number of bytes to be downloaded
- **x:** not used, always 0
- **reserved:** reserved for further use, always 0

Figure 21: Protocol SDO download initiate

7.2.4.3.4 Protocol SDO download segment

The protocol as defined in Figure 22 shall be used to implement the SDO download segment service.

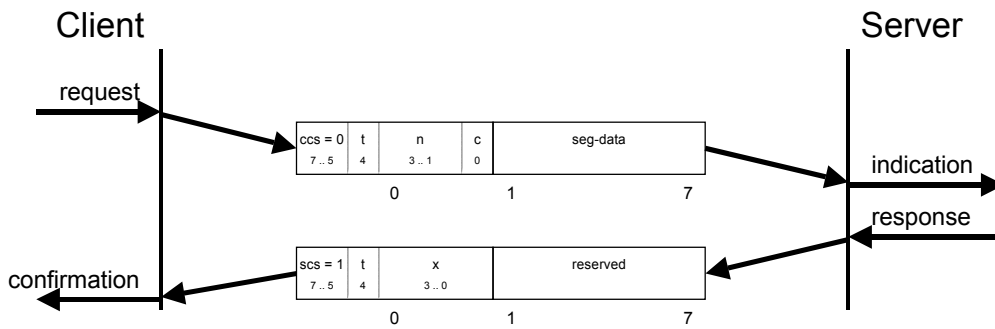

- **ccs**: client command specifier
0: download segment request
- **scs**: server command specifier
1: download segment response
- **seg-data**: at most 7 bytes of segment data to be downloaded. The encoding depends on the type of the data referenced by index and sub-index
- **n**: indicates the number of bytes in seg-data that do not contain segment data. Bytes [8-n, 7] do not contain segment data. If n = 0 bytes 1 to 7 shall contain segment data.
NOTE: If the size in the initiation is indicated this applies to the overall data transferred.
- **c**: indicates whether there are still more segments to be downloaded.
0 more segments to be downloaded
1: no more segments to be downloaded
- **t**: toggle bit. This bit shall alternate for each subsequent segment that is downloaded. The first segment shall have the toggle-bit set to 0. The toggle bit shall be equal for the request and the response message.
- **X**: not used, always 0
- **reserved**: reserved for further use, always 0

Figure 22: Protocol SDO segment download

7.2.4.3.5 Protocol SDO upload

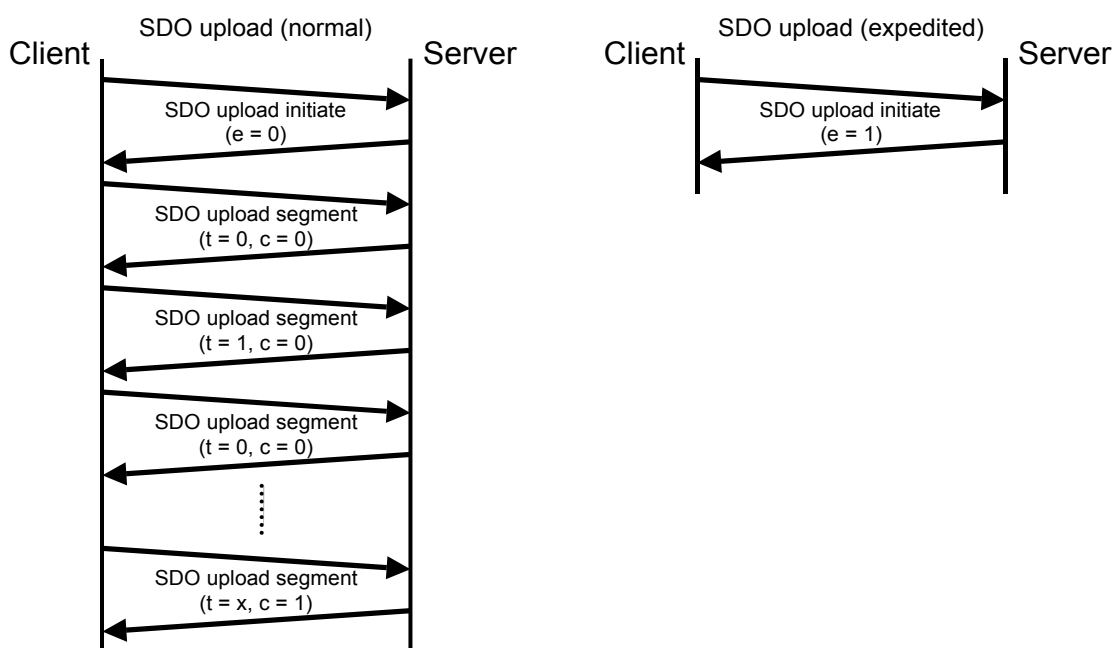

Figure 23: Protocol SDO upload

This protocol (specified in Figure 23) shall be used to implement the SDO upload service. SDOs are uploaded as a sequence of zero or more SDO upload segment services preceded by an SDO upload initiate service. The sequence is terminated by:

- An SDO upload initiate response/confirm with the e-bit set to 1, indicating the successful completion of an expedited upload sequence.
- An SDO upload segment response/confirm with the c-bit set to 1, indicating the successful completion of a normal upload sequence.
- An SDO abort transfer request/indication, indicating the unsuccessful completion of the upload sequence.
- A new SDO upload initiate request/indication, indicating the unsuccessful completion of the upload sequence and the start of a new sequence.

If in the upload of two consecutive segments the toggle bit does not alter, the content of the last segment shall be ignored. If such an error is reported to the application, the application may decide to abort the upload.

7.2.4.3.6 Protocol SDO upload initiate

The protocol as defined in Figure 24 shall be used to implement the SDO upload initiate service.

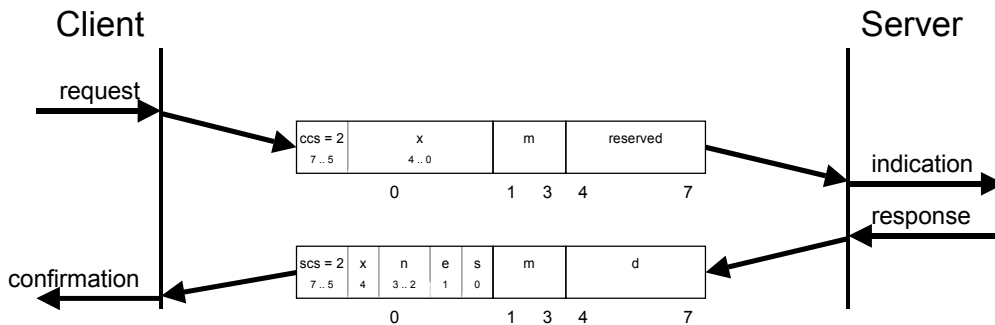

- **ccs**: client command specifier
2: initiate upload request
- **scs**: server command specifier
2: initiate upload response
- **n**: Only valid if e = 1 and s = 1, otherwise 0. If valid it indicates the number of bytes in d that do not contain data. Bytes [8-n, 7] do not contain segment data.
- **e**: transfer type
0: normal transfer
1: expedited transfer
- **s**: size indicator
0: data set size is not indicated
1: data set size is indicated
 - **m**: multiplexer. It represents the index/sub-index of the data to be transfer by the SDO.
- **d**: data
e = 0, s = 0: d is reserved for further use.
e = 0, s = 1: d contains the number of bytes to be uploaded.
Byte 4 contains the lsb and byte 7 contains the msb.
e = 1, s = 1: d contains the data of length 4-n to be uploaded,
the encoding depends on the type of the data referenced by index and sub-index
e = 1, s = 0: d contains unspecified number of bytes to be uploaded.
- **X**: not used, always 0
- **reserved**: reserved for further use , always 0

Figure 24: Protocol SDO upload initiate

7.2.4.3.7 Protocol SDO upload segment

The protocol as defined in Figure 25 shall be used to implement the SDO upload segment service.

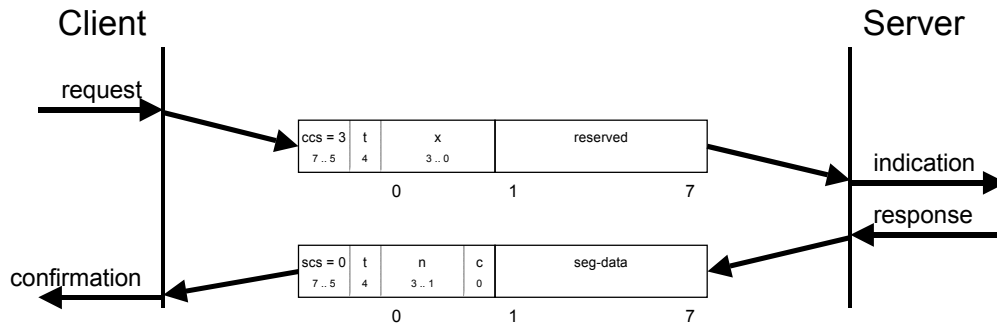

- **ccs**: client command specifier
3: upload segment request
- **scs**: server command specifier
0: upload segment response
- **t**: toggle bit. This bit shall alternate for each subsequent segment that is uploaded. The first segment shall have the toggle-bit set to 0. The toggle bit shall be equal for the request and the response message.
- **c**: indicates whether there are still more segments to be uploaded.
0: more segments to be uploaded
1: no more segments to be uploaded
- **seg-data**: at most 7 bytes of segment data to be uploaded. The encoding depends on the type of the data referenced by index and sub-index
- **n**: indicates the number of bytes in seg-data that do not contain segment data. Bytes [8-n, 7] do not contain segment data. If n = 0 bytes 1 to 7 shall contain segment data.
NOTE: If the size in the initiation is indicated this applies to the overall data transferred.
- **X**: not used, always 0
- **reserved**: reserved for further use, always 0

Figure 25: Protocol SDO segment upload

7.2.4.3.8 Protocol SDO block download

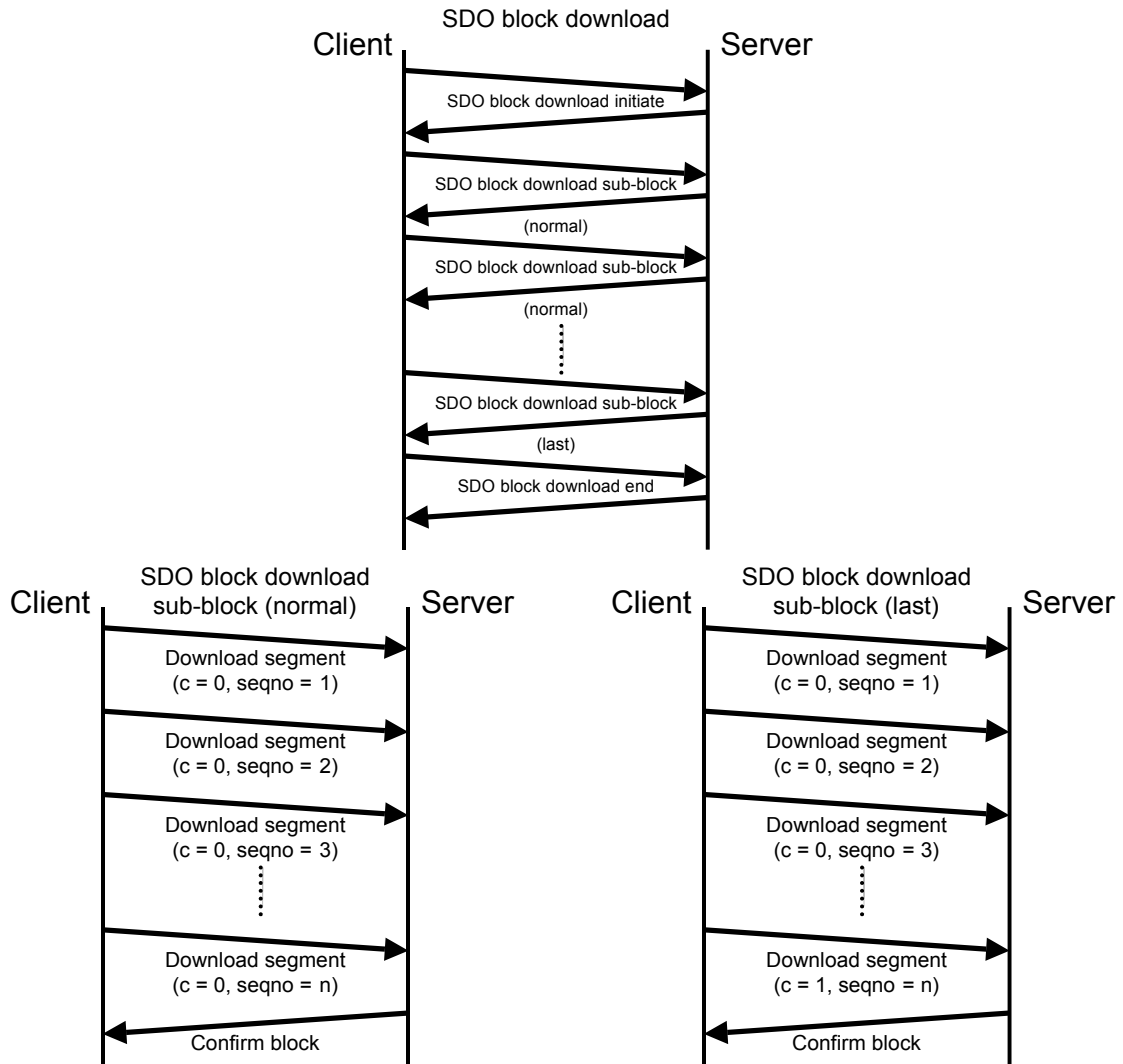

Figure 26: Protocol SDO block download

This protocol (specified in Figure 26) shall be used to implement an SDO block download service. SDOs are downloaded as a sequence of SDO block download sub-block services preceded by an SDO block download initiate service. The SDO block download sub-block sequence is terminated by:

- A downloaded segment within a block with the c-bit set to 1, indicating the completion of the SDO block download sequence.
- An SDO abort transfer request/indication, indicating the unsuccessful completion of the download sequence.

The SDO block download service is terminated with the SDO block download end service. If both the client and the server have indicated the ability to generate a CRC during the SDO block download initiate service the server shall generate the CRC on the received data. If this CRC differs from the CRC generated by the client the server shall indicate this with an SDO abort transfer indication.

7.2.4.3.9 Protocol SDO block download initiate

The protocol as defined in Figure 27 shall be used to implement the SDO block download initiate service.

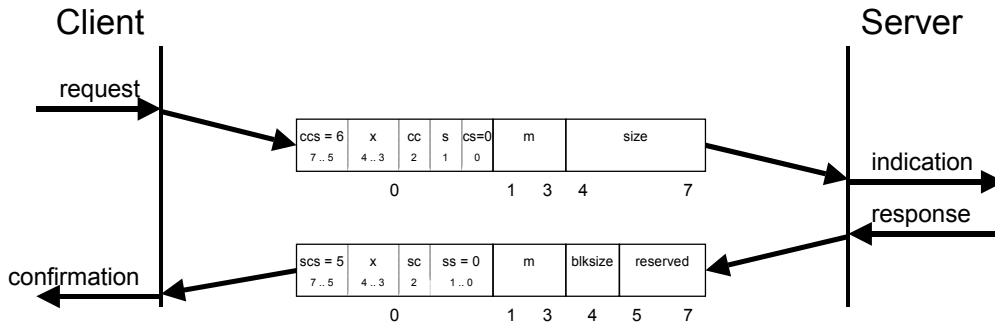

- **ccs**: client command specifier
- 6: block download
- **scs**: server command specifier
- 5: block download
- **s**: size indicator
- 0: data set size is not indicated
- 1: data set size is indicated
- **cs**: client subcommand
- 0: initiate download request
- **ss**: server subcommand
- 0: initiate download response
- **cc**: client CRC support
- cc = 0: Client does not support generating CRC on data
- cc = 1: Client supports generating CRC on data
- **sc**: server CRC support
- sc = 0: Server does not support generating CRC on data
- sc = 1: Server supports generating CRC on data
- **m**: multiplexer. It represents the index/sub-index of the data to be transfer by the SDO.
- **size**: download size in bytes
- s = 0: size is reserved for further use, always 0
- s = 1: size contains the number of bytes to be downloaded
- Byte 4 contains the LSB and byte 7 the MSB
- **blksize**: Number of segments per block that shall be used by the client for the following block download with $0 < \text{blksize} < 128$
- **X**: not used, always 0
- **reserved**: reserved for further use, always 0

Figure 27: Protocol SDO block download initiate

7.2.4.3.10 Protocol SDO block download sub-block

The protocol as defined in Figure 28 shall be used to implement the SDO block download sub-block service.

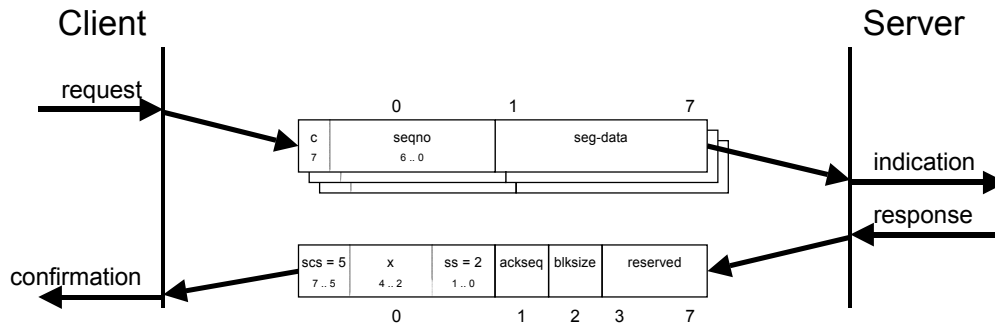

scs: server command specifier

5: block download

ss: server subcommand

2: block download response

- **c:** indicates whether there are still more segments to be downloaded
 - 0: more segments to be downloaded
 - 1: no more segments to be downloaded, enter SDO block download end phase

seqno: sequence number of segment $0 < \text{seqno} < 128$.

seg-data: at most 7 bytes of segment data to be downloaded.

ackseq: sequence number of last segment that was received successfully during the last block download. If ackseq is set to 0 the server indicates the client that the segment with the sequence number 1 was not received correctly and all segments shall be retransmitted by the client.

- **blksize:** Number of segments per block that shall be used by the client for the following block download with $0 < \text{blksize} < 128$.
- **X:** not used, always 0
- **reserved:** reserved for further use, always 0

Figure 28: Protocol SDO block download sub-block

7.2.4.3.11 Protocol SDO block download end

The protocol as defined in Figure 29 shall be used to implement the SDO block download end service.

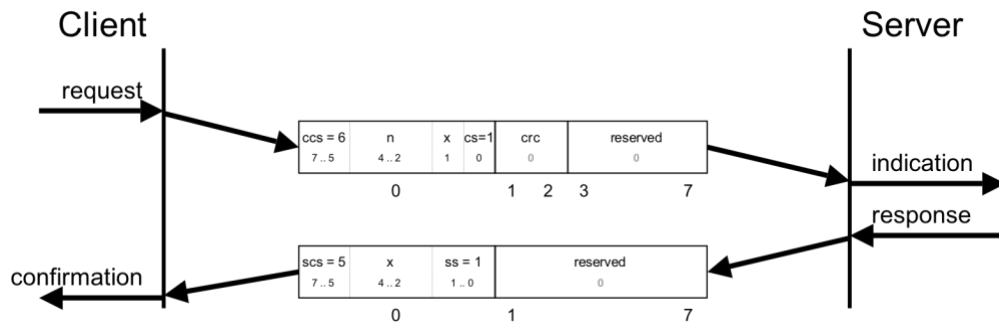

ccs: client command specifier

6: block download

scs: server command specifier

5: block download

cs: client subcommand

1: end block download request

ss: server subcommand

1: end block download response

n: indicates the number of bytes in the last segment of the last block that do not contain data. Bytes [8-n, 7] do not contain segment data.

crc: 16 bit cyclic redundancy checksum (CRC) for the data set. The algorithm for generating the CRC is described in sub-clause 7.2.4.3.16. CRC is only valid if in SDO block download initiate cc and sc are set to 1 otherwise CRC shall be set to 0.

X: not used, always 0

reserved: reserved for further use, always 0

Figure 29: Protocol SDO block download end

7.2.4.3.12 Protocol SDO block upload

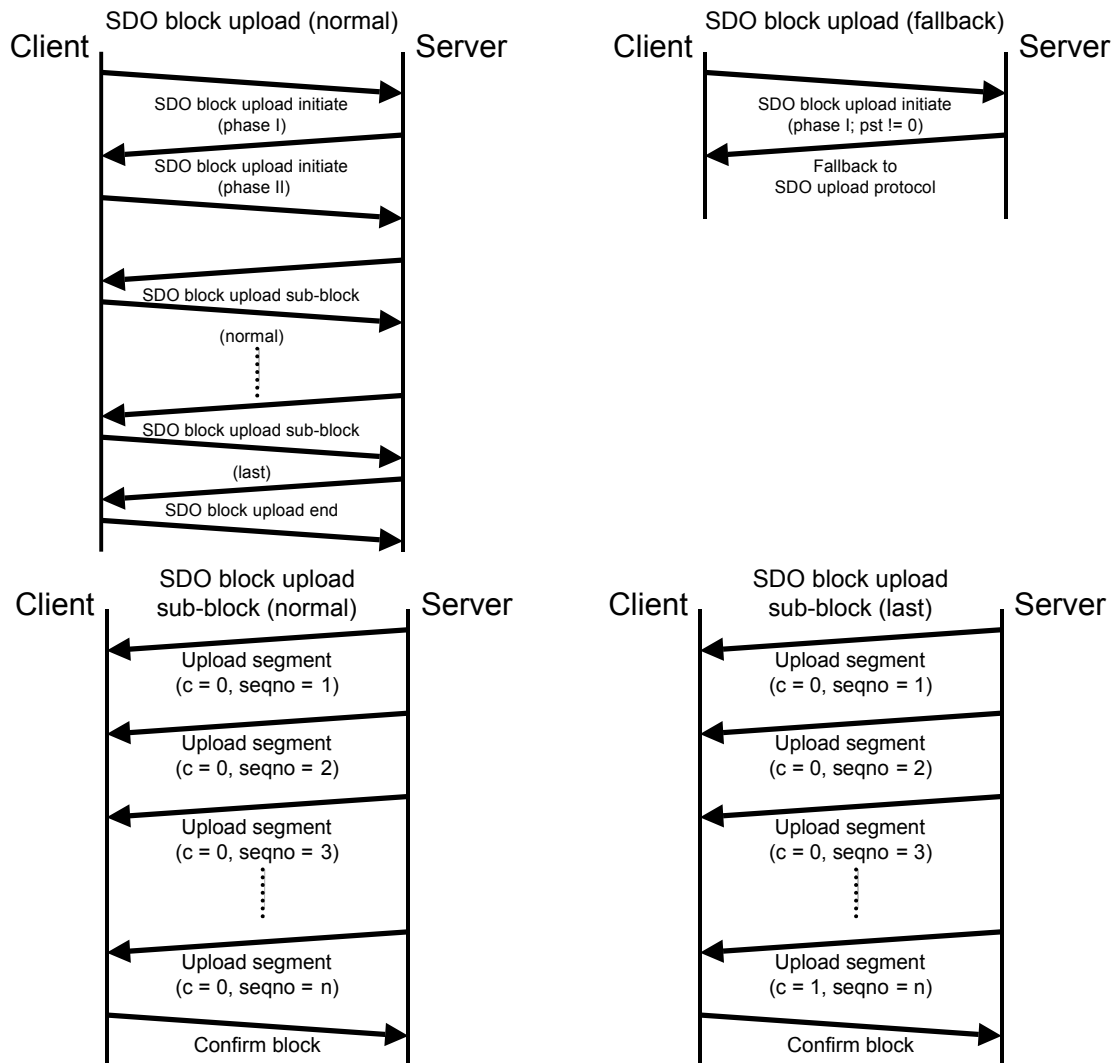

Figure 30: Protocol SDO block upload

This protocol (specified in Figure 30) shall be used to implement an SDO block upload service which starts with the SDO block upload initiate service. The client may indicate a threshold value to the server which is the minimum value in bytes to increase transfer performance using the SDO block upload protocol instead of the SDO upload protocol. If the data set size is less or equal this value the server may continue with the normal or expedited transfer of the SDO block upload protocol.

Otherwise SDOs are uploaded as a sequence of SDO block upload sub-block services. The SDO block upload sub-block sequence is terminated by:

- An uploaded segment within a block with the c-bit set to 1, indicating the completion of the SDO block upload sub-block sequence.
- AN SDO abort transfer request/indication is indicating the unsuccessful completion of the uploaded sequence.

The SDO block upload service is terminated with the SDO block upload end service. If both the client and the server have indicated the ability to generate a CRC during the SDO block upload initiate service the client shall generate the CRC on the received data. If this CRC differs from the CRC generated by the server the client shall indicate this with an SDO abort transfer indication.

7.2.4.3.13 Protocol SDO block upload initiate

The protocol as defined in Figure 31 shall be used to implement the SDO block upload initiate service. If the value of the protocol switch threshold parameter indicated by the client in the first request is less or equal the data set size to be uploaded the server may continue with the protocol SDO upload as described in sub-clause 7.2.4.3.5.

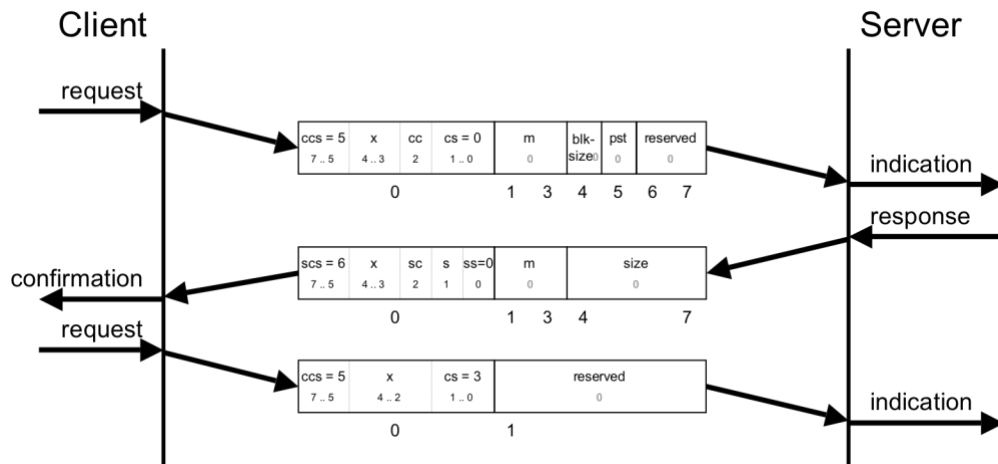

- **ccs**: client command specifier
- 5: block upload
- **scs**: server command specifier
- 6: block upload
- **cs**: client subcommand
- 0: initiate upload request
- 3: start upload
- **ss**: server subcommand
- 0: initiate upload response
- **m**: multiplexer. It represents the index/sub-index of the data to be transfer by the SDO.
- **cc**: client CRC support

cc = 0: Client does not support generating CRC on data

cc = 1: Client supports generating CRC on data

- **sc**: server CRC support

sc = 0: Server does not support generating CRC on data

sc = 1: Server supports generating CRC on data

- **pst**: protocol switch threshold in bytes to change the SDO transfer protocol

pst = 0: Change of transfer protocol not allowed.

pst > 0: If the size of the data in bytes is less or equal pst the server may switch to the SDO upload protocol by transmitting the server response of the protocol SDO upload as described in sub-clause 7.2.4.3.5.

- **s**: size indicator

0: data set size is not indicated

1: data set size is indicated

size: upload size in bytes

s = 0: size is reserved for further use, always 0

s = 1: size contains the number of bytes to be downloaded

Byte 4 contains the lsb and byte 7 the msb

- **blksize**: Number of segments per block with $0 < \text{blksize} < 128$.
- **X**: not used, always 0
- **reserved**: reserved for further use, always 0

Figure 31: Protocol SDO block upload initiate

7.2.4.3.14 Protocol SDO block upload sub-block

The protocol as defined in Figure 32 shall be used to implement the SDO block upload sub-block service.

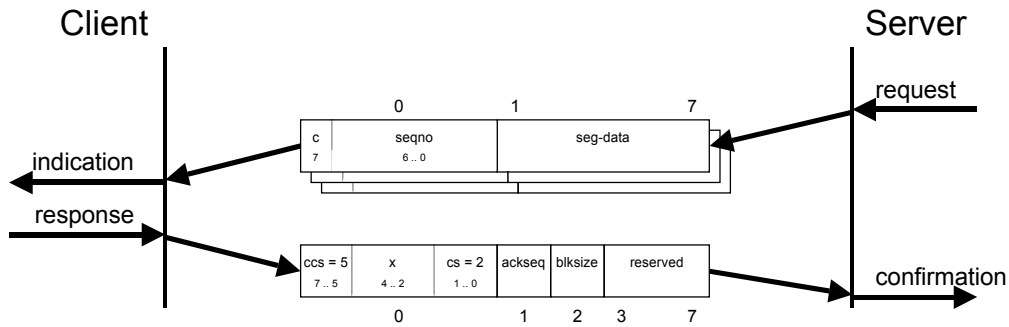

- **ccs**: client command specifier
5: block upload
- cs**: client subcommand
2: block upload response
- **c**: indicates whether there are still more segments to be downloaded
0: more segments to be uploaded
1: no more segments to be uploaded, enter 'End block upload' phase
- seqno**: sequence number of segment $0 < \text{seqno} < 128$.
- **seg-data**: at most 7 bytes of segment data to be uploaded.
- **ackseq**: sequence number of last segment that was received successfully during the last block upload. If **ackseq** is set to 0 the client indicates the server that the segment with the sequence number 1 was not received correctly and all segments shall be retransmitted by the server.
- **blksize**: Number of segments per block that shall be used by server for the following block upload with $0 < \text{blksize} < 128$.
- **X**: not used, always 0
- **reserved**: reserved for further use, always 0

Figure 32: Protocol SDO block upload sub-block

7.2.4.3.15 Protocol SDO block upload end

The protocol as defined in Figure 33 shall be used to implement the SDO block upload end service.

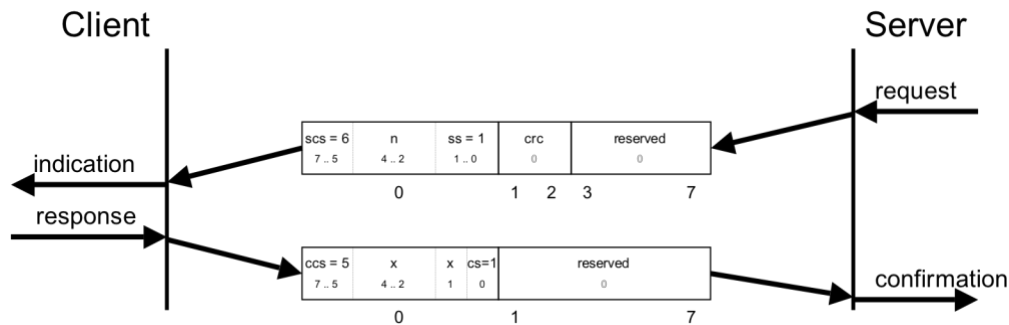

ccs: client command specifier

5: block upload

- **scs:** server command specifier

6: block upload

- **cs:** client subcommand

1: end block upload request

- **ss:** server subcommand

1: end block upload response

- **n:** indicates the number of bytes in the last segment of the last block that do not contain data. Bytes [8-n, 7] do not contain segment data.

crc: 16 bit cyclic redundancy checksum (CRC) of the data set. The algorithm for generating the CRC is described in clause 7.2.4.3.16. CRC is only valid if in SDO block upload initiate cc and sc are set to 1 otherwise crc shall be set to 0.

- **X:** not used, always 0

- **reserved:** reserved for further use, always 0

Figure 33: Protocol SDO block upload end

7.2.4.3.16 CRC calculation algorithm to verify SDO block transfer

To verify the correctness of an SDO block upload and SDO block download client and server calculating a CRC that is exchanged and verified during SDO block download end and SDO block upload end protocol. The CRC shall have the following parameters:

- CRC polynomial: $x^{16} + x^{12} + x^5 + 1$
- CRC width: 16 bit
- initial value: 0000_h
- CRC check (result for CRC of 123456789): 31C3_h

7.2.4.3.17 Protocol SDO abort transfer

The protocol as defined in Figure 34 shall be used to implement the SDO abort transfer service.

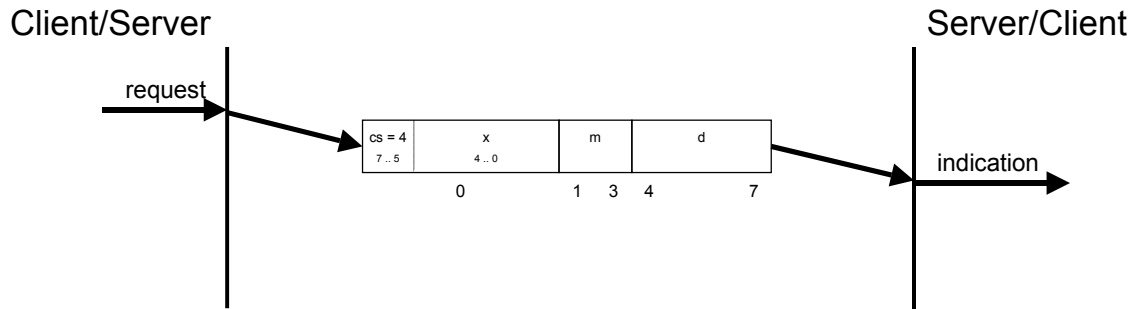

- **cs**: command specifier
4: abort transfer request
- **X**: not used, always 0
- **m**: multiplexer. It represents index and sub-index of the SDO.
- **d**: contains a 4 byte abort code about the reason for the abort.

Figure 34: Protocol SDO abort transfer

The abort code as defined in Table 22 is encoded as UNSIGNED32 value.

Table 22: SDO abort codes

Abort code	Description
0503 0000 _h	Toggle bit not alternated.
0504 0000 _h	SDO protocol timed out.
0504 0001 _h	Client/server command specifier not valid or unknown.
0504 0002 _h	Invalid block size (block mode only).
0504 0003 _h	Invalid sequence number (block mode only).
0504 0004 _h	CRC error (block mode only).
0504 0005 _h	Out of memory.
0601 0000 _h	Unsupported access to an object.
0601 0001 _h	Attempt to read a write only object.
0601 0002 _h	Attempt to write a read only object.
0602 0000 _h	Object does not exist in the object dictionary.
0604 0041 _h	Object cannot be mapped to the PDO.
0604 0042 _h	The number and length of the objects to be mapped would exceed PDO length.
0604 0043 _h	General parameter incompatibility reason.
0604 0047 _h	General internal incompatibility in the device.
0606 0000 _h	Access failed due to an hardware error.
0607 0010 _h	Data type does not match, length of service parameter does not match
0607 0012 _h	Data type does not match, length of service parameter too high
0607 0013 _h	Data type does not match, length of service parameter too low
0609 0011 _h	Sub-index does not exist.

Abort code	Description
0609 0030 _h	Invalid value for parameter (download only).
0609 0031 _h	Value of parameter written too high (download only).
0609 0032 _h	Value of parameter written too low (download only).
0609 0036 _h	Maximum value is less than minimum value.
060A 0023 _h	Resource not available: SDO connection
0800 0000 _h	General error
0800 0020 _h	Data cannot be transferred or stored to the application.
0800 0021 _h	Data cannot be transferred or stored to the application because of local control.
0800 0022 _h	Data cannot be transferred or stored to the application because of the present device state.
0800 0023 _h	Object dictionary dynamic generation fails or no object dictionary is present (e.g. object dictionary is generated from file and generation fails because of a file error).
0800 0024 _h	No data available

The abort codes not listed shall be reserved.

7.2.5 Synchronization object (SYNC)

7.2.5.1 General

The SYNC producer broadcasts the synchronization object periodically. This SYNC provides the basic network synchronization mechanism. The time period between the SYNCs is specified by the standard parameter communication cycle period (see sub-clause 7.5.2.6), which may be written by a configuration tool to the CANopen devices during the boot-up process. There may be a time jitter in transmission by the SYNC producer corresponding approximately to the latency due to some other message being transmitted just before the SYNC. The SYNC consumer may use the communication cycle period manufacturer specific.

The optional parameter counter is used to define an explicit relationship between the current SYNC cycle and PDO transmission (see PDO communication parameter SYNC start value at sub-clause 7.5.2.37).

In order to guarantee timely access to the network the SYNC is given a very high priority CAN-ID (see sub-clause 7.5.2.5). CANopen devices that operate synchronously may use the SYNC object to synchronize their own timing with that of the synchronization object producer. The details of this synchronization are application-specific and do not fall within the scope of this specification.

7.2.5.2 SYNC services

7.2.5.2.1 General

The SYNC transmission follows the producer/consumer push model as described in clause 4.4.4. The service is unconfirmed.

Attributes:

- user type: one of the values {consumer, producer}
- data type: UNSIGNED8

7.2.5.2.2 Service SYNC write

For the SYNC write service the push model is valid. There are zero or more consumers for SYNC. The SYNC has exactly one producer. The parameter for this service is defined in Table 23.

Through this service the producer of the SYNC sends a trigger event to the consumer(s).

Table 23: Service SYNC write

<i>Parameter</i>	<i>Request / Indication</i>
Argument counter	Mandatory optional

The service is unconfirmed. The optional parameter counter shall be incremented by 1 with every transmission. The maximum value shall be the current value as defined in the synchronous counter overflow value (see sub-clause 7.5.2.22). In case the maximum value is reached the counter shall be set to 1 with the next transmission. The initial value of the counter after the NMT service boot-up shall be 1. The value of the counter shall be reset to 1 if the CANopen device transits from the NMT state stopped into the NMT state pre-operational or into the NMT state operational.

7.2.5.3 SYNC protocol

7.2.5.3.1 Protocol SYNC write

This protocol as defined in Figure 35 shall be used to implement the service SYNC write.

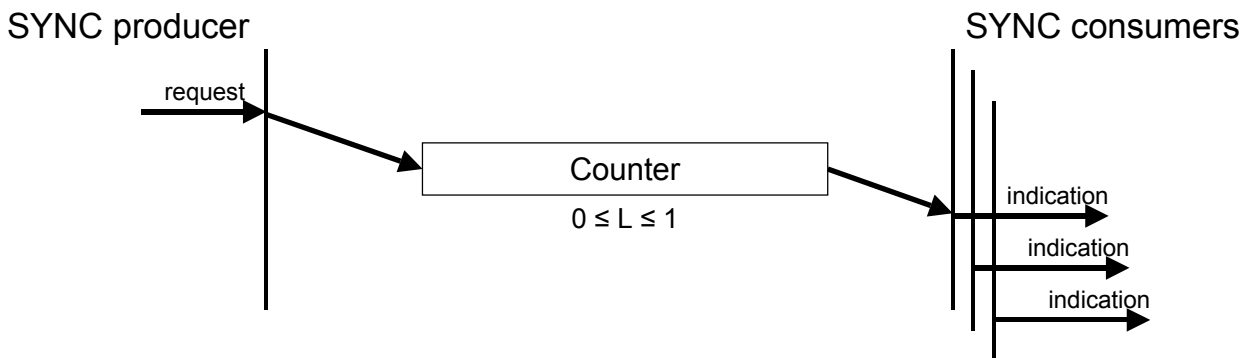

- **Counter:** 1 byte of a counter

Figure 35: Protocol SYNC write

7.2.6 Time stamp object (TIME)

7.2.6.1 General

The TIME producer broadcasts the time stamp object. This TIME provides the simple network clock. There may be a time jitter in transmission by the TIME producer corresponding approximately to the latency due to some other message being transmitted just before the TIME.

In order to guarantee timely access to the network the TIME is given a very high priority CAN-ID (see sub-clause 7.5.2.15). CANopen devices that operate a local clock may use the TIME object to adjust their own time base to that of the time stamp object producer. The details of this mechanism are implementation specific and do not fall within the scope of this specification.

7.2.6.2 TIME services

7.2.6.2.1 General

The time stamp object transmission follows the producer/consumer as described in sub-clause 4.4.4. The service is unconfirmed.

Attributes:

- user type: one of the values {consumer, producer}
- data type: TIME_OF_DAY

7.2.6.2.2 Service TIME write

For the TIME write service the push model is valid. There are zero or more consumers of a TIME. A TIME has exactly one producer. The parameter for this service is defined in Table 24.

Through this service the producer of a TIME sends the current time to the consumer(s).

Table 24: Service TIME write

<i>Parameter</i>	<i>Request / Indication</i>
Argument Data	Mandatory mandatory

The service is unconfirmed.

7.2.6.3 TIME protocol

7.2.6.3.1 Protocol TIME write

This protocol as defined in Figure 36 shall be used to implement the service TIME write.

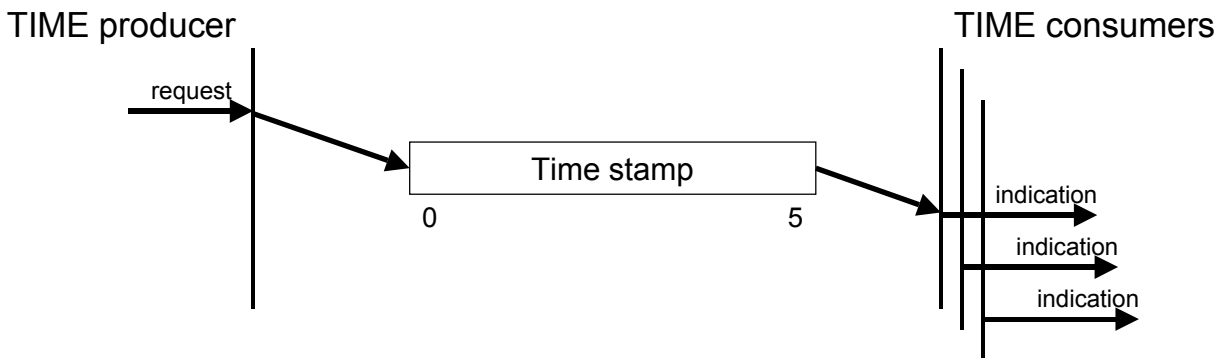

- **Time stamp:** 6 bytes of the time stamp object

Figure 36: Protocol TIME write

7.2.7 Emergency object (EMCY)

7.2.7.1 Emergency object usage

Emergency objects are triggered by the occurrence of a CANopen device internal error situation and are transmitted from an emergency producer on the CANopen device. Emergency objects are suitable for interrupt type error alerts. An emergency object is transmitted only once per 'error event'. No further emergency objects shall be transmitted as long as no new errors occur on a CANopen device.

Zero or more emergency consumers may receive the emergency object. The reaction on the emergency consumer(s) is not specified and does not fall in the scope of this specification.

By means of this specification emergency error code classes (Table 25), emergency error codes (Table 26) and the error register (see sub-clause 7.5.2.2) are specified. Application-specific additional information in the lower byte of the emergency error code and the emergency condition do not fall into the scope of this specification. Additional error codes are defined by other profile specifications.

Table 25: Emergency error code classes

Error code	Description
00xX _h	Error reset or no error
10xX _h	Generic error
20xX _h	Current
21xX _h	Current, CANopen device input side
22xX _h	Current inside the CANopen device
23xX _h	Current, CANopen device output side
30xX _h	Voltage
31xX _h	Mains voltage

Error code	Description
32xx _h	Voltage inside the CANopen device
33xx _h	Output voltage
40xx _h	Temperature
41xx _h	Ambient temperature
42xx _h	CANopen device temperature
50xx _h	CANopen device hardware
60xx _h	CANopen device software
61xx _h	Internal software
62xx _h	User software
63xx _h	Data set
70xx _h	Additional modules
80xx _h	Monitoring
81xx _h	Communication
82xx _h	Protocol error
90xx _h	External error
F0xx _h	Additional functions
FFxx _h	CANopen device specific

Table 26: Emergency error codes

Error code	Description
0000 _h	Error reset or no error
1000 _h	Generic error
2000 _h	Current – generic error
2100 _h	Current, CANopen device input side – generic
2200 _h	Current inside the CANopen device – generic
2300 _h	Current, CANopen device output side – generic
3000 _h	Voltage – generic error
3100 _h	Mains voltage – generic
3200 _h	Voltage inside the CANopen device – generic
3300 _h	Output voltage – generic
4000 _h	Temperature – generic error
4100 _h	Ambient temperature – generic
4200 _h	Device temperature – generic
5000 _h	CANopen device hardware – generic error
6000 _h	CANopen device software – generic error

Error code	Description
6100 _h	Internal software – generic
6200 _h	User software – generic
6300 _h	Data set – generic
7000 _h	Additional modules – generic error
8000 _h	Monitoring – generic error
8100 _h	Communication – generic
8110 _h	CAN overrun (objects lost)
8120 _h	CAN in error passive mode
8130 _h	Life guard error or heartbeat error
8140 _h	recovered from bus off
8150 _h	CAN-ID collision
8200 _h	Protocol error - generic
8210 _h	PDO not processed due to length error
8220 _h	PDO length exceeded
8230 _h	DAM MPDO not processed, destination object not available
8240 _h	Unexpected SYNC data length
8250 _h	RPDO timeout
9000 _h	External error – generic error
F000 _h	Additional functions – generic error
FF00 _h	Device specific – generic error

The emergency object is optional. If a CANopen device supports the emergency object, it shall support at least the two error codes 0000_h and 1000_h. All other error codes are optional.

A CANopen device shall be in one of two emergency states (Figure 37). Dependent on the transitions emergency objects shall be transmitted. Links between the error state machine and the NMT state machine are defined by object 1029_h (see sub-clause 7.5.2.32).

0. After initialization the CANopen device enters the error free state if no error is detected. No error message is sent.
1. The CANopen device detects an internal error indicated in the first three bytes of the emergency message (error code and error register). The CANopen device enters the error state. An emergency object with the appropriate error code and error register is transmitted. The error code is filled in at the location of object 1003_h (pre-defined error field).
2. One, but not all error reasons are gone. An emergency message containing error code 0000_h (Error reset) may be transmitted together with the remaining errors in the error register and in the manufacturer-specific error field.
3. A new error occurs on the CANopen device. The CANopen device remains in error state and transmits an emergency object with the appropriate error code. The new error code is filled in at the top of the array of error codes (1003_h). It shall be guaranteed that the error codes are sorted in a timely manner (oldest error - highest sub-index, see object 1003_h).
4. All errors are repaired. The CANopen device enters the error free state and transmits an emergency object with the error code 'reset error / no error'.
5. Reset or power-off.

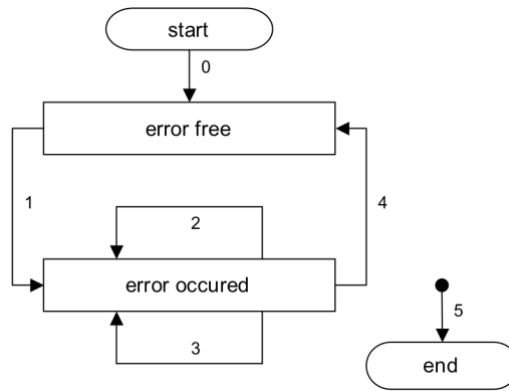

Figure 37: Emergency state transition diagram

7.2.7.2 Emergency object services

7.2.7.2.1 General

The emergency object transmission follows the producer/consumer as described in sub-clause 4.4.4. The service is unconfirmed.

The following object attributes are specified for emergency objects:

- user type: one of the values {consumer, producer}
- data type: STRUCTURE OF
 UNSIGNED16 emergency_error_code,
 UNSIGNED8 error_register,
 ARRAY (5) of UNSIGNED8 manufacturer_specific_error_field
- inhibit-time: n*100 μs, n ≥ 0

7.2.7.2.2 Service EMCY write

For the EMCY write service the push model is valid. There are zero or more consumers for EMCY. EMCY has exactly one producer. The parameter for this service is defined in Table 27.

Through this service the producer of EMCY sends the current emergency data to the consumer(s).

Table 27: Service EMCY write

<i>Parameter</i>	<i>Request / Indication</i>
Argument Data	Mandatory mandatory

The service is unconfirmed.

7.2.7.3 Emergency object protocol

7.2.7.3.1 Protocol EMCY write

This protocol as defined in Figure 38 shall be used to implement the service EMCY write.

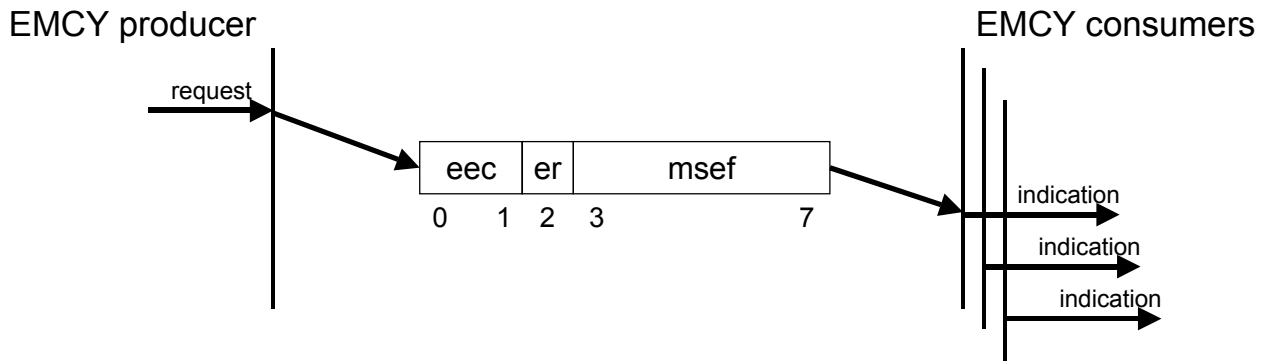

- **eec**: Emergency error code (see Table 26)
- **er**: Error register (see object 1001_h)
- **msef**: Manufacturer-specific error code

Figure 38: Protocol EMCY write

A RTR is not allowed to inquire for an emergency transmission. A received RTR shall not be answered.

7.2.8 Network management

7.2.8.1 General

The network management (NMT) is CANopen device oriented and follows a master-slave structure. NMT objects are used for executing NMT services. Through NMT services, CANopen devices are initialized, started, monitored, reset or stopped. All CANopen devices are regarded as NMT slaves. An NMT slave is uniquely identified in the network by its node-ID, a value in the range of [1..127].

NMT requires that one CANopen device in the network fulfils the function of the NMT master.

7.2.8.2 NMT services

7.2.8.2.1 Node control services

7.2.8.2.1.1 General

Through node control services, the NMT master controls the NMT state of the NMT slaves. The NMT state attribute is one of the values {Stopped, Pre-operational, Operational, Initialisation}. The node control services may be performed with a certain CANopen device or with all CANopen devices simultaneously. The NMT master controls its own NMT state machine via local services, which are implementation dependent. The node control services may be initiated by the local application.

7.2.8.2.1.2 Service start remote node

The NMT master uses the NMT service start remote node to change the NMT state of the selected NMT slaves. The new NMT state shall be the NMT state operational. The parameters for this service are defined in Table 28.

Table 28: Service start remote node

Parameter	Indication/Request
Argument Node-ID All	Mandatory selection selection

The service is unconfirmed and mandatory.

7.2.8.2.1.3 Service stop remote node

The NMT master uses the NMT service stop remote node to change the NMT state of the selected NMT slaves. The new NMT state shall be the NMT state stopped. The parameters for this service are defined in Table 29.

Table 29: Service stop remote node

<i>Parameter</i>	<i>Request/Indication</i>
Argument Node-ID All	Mandatory selection selection

The service is unconfirmed and mandatory.

7.2.8.2.1.4 Service enter pre-operational

The NMT master uses the NMT service enter pre-operational to change the NMT state of the selected NMT slaves. The new NMT state shall be the NMT state pre-operational. The parameters for this service are defined in Table 30.

Table 30: Service enter pre-operational

<i>Parameter</i>	<i>Request/Indication</i>
Argument Node-ID All	Mandatory selection selection

The service is unconfirmed and mandatory.

7.2.8.2.1.5 Service reset node

The NMT master uses the NMT service reset node to change the NMT state of the selected NMT slaves. The new NMT state shall be the NMT sub-state reset application. The parameters for this service are defined in Table 31.

Table 31: Service reset node

<i>Parameter</i>	<i>Request/Indication</i>
Argument Node-ID All	Mandatory selection selection

The service is unconfirmed and mandatory.

7.2.8.2.1.6 Service reset communication

The NMT master uses the NMT service reset communication to change the NMT state of the selected NMT slaves. The new NMT state shall be the NMT sub-state reset communication. The parameters for this service are defined in Table 32.

Table 32: Service reset communication

<i>Parameter</i>	<i>Request/Indication</i>
Argument Node-ID All	Mandatory selection selection

The service is unconfirmed and mandatory.

7.2.8.2.2 Error control services

The error control services are used to detect failures within a CAN-based network.

Local errors in a CANopen device may e.g. lead to a reset or change of state. The definition of these local errors does not fall into the scope of this specification.

Error control services are achieved principally through periodically transmitting of messages by a CANopen device. There exist two possibilities to perform error control.

The guarding is achieved by transmitting guarding requests (node guarding protocol) by the NMT master. If a NMT slave has not responded within a defined span of time (node life time) or if the NMT slave's communication status has changed, the NMT master informs its NMT master application about that event.

If life guarding (the NMT slave guarding the NMT master) is supported, the NMT slave uses the guard time and life time factor from its object dictionary to determine its node lifetime. If the NMT slave is not guarded within its lifetime, the NMT slave informs its local application about that event. If guard time and life time factor are 0 (default values), the NMT slave does not guard the NMT master.

Guarding starts for the NMT slave when the first RTR for its guarding CAN-ID is received. This may be during the boot-up phase or later.

The heartbeat mechanism for a CANopen device is established by cyclically transmitting the heartbeat message by the heartbeat producer. One or more CANopen devices in the network are aware of this heartbeat message. If the heartbeat cycle fails for the heartbeat producer the local application on the heartbeat consumer will be informed about that event.

The implementation of either guarding or heartbeat is mandatory.

NOTE: Even though both Heartbeat and Guarding are disabled by default, it is recommended to use error control mechanisms.

7.2.8.2.2.1 Service node guarding event

Through this service, the NMT service provider on the NMT master indicates that a remote error is occurred or is resolved for the remote CANopen device identified by node-ID. The parameters for this service are defined in Table 33.

The event resolved is indicated

- when after the event occurred with the reason state change the expected state is received, or
- when after the event occurred with the reason time out one of the subsequent remote indications is confirmed.

Table 33: Service node guarding event

<i>Parameter</i>	<i>Indication</i>
Argument	Mandatory
Node-ID	mandatory
State	mandatory
Occurred	selection
Resolved	selection
Reason	optional
Time out	selection
State change	selection

The service is provider initiated and optional.

7.2.8.2.2.2 Service life guarding event

Through this service, the NMT service provider on an NMT slave indicates that a remote error occurred or has been resolved. The parameters for this service are defined in Table 34.

The event resolved is indicated when after the event occurred a subsequent remote request is received.

Table 34: Service life guarding event

<i>Parameter</i>	<i>Indication</i>
Argument	Mandatory
State	mandatory
Occurred	selection
Resolved	selection

The service is provider initiated and optional.

7.2.8.2.2.3 Service heartbeat event

Through this service, the heartbeat consumer shall indicate that a heartbeat error occurred or has been resolved or a NMT state change has occurred for the CANOpen device identified by node-ID. The parameters for this service are defined in Table 35.

The event resolved is indicated when after the event occurred a subsequent remote indication is received.

Table 35: Service heartbeat event

<i>Parameter</i>	<i>Indication</i>
Argument	Mandatory
Node-ID	mandatory
State	mandatory
Occurred	selection
Resolved	selection
Reason	mandatory
Time out	selection
State change	selection

The service is consumer initiated and optional.

7.2.8.2.3 Boot-up service

7.2.8.2.3.1 Service boot-up Event

Through this service, the NMT slave indicates that a local state transition occurred from the NMT state Initialisation to the NMT state Pre-operational. The parameter for this service is defined in Table 36.

Table 36: Service boot-up event

<i>Parameter</i>	<i>Indication</i>
Argument	Mandatory
Node-ID	mandatory

The service is provider initiated and mandatory.

7.2.8.3 NMT protocols

7.2.8.3.1 Node control protocols

7.2.8.3.1.1 Protocol start remote node

The protocol as defined in Figure 39 shall be used to implement the NMT service start remote node.

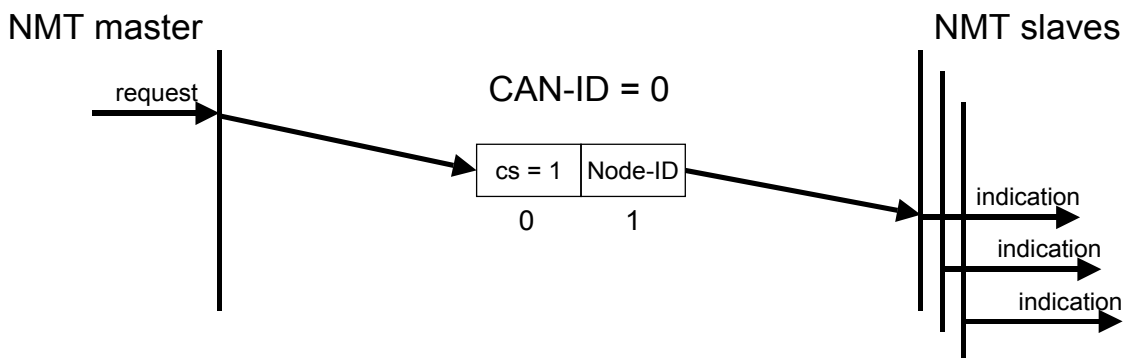

cs: NMT command specifier
 1: start

Figure 39: Protocol start remote node

7.2.8.3.1.2 Protocol stop remote node

The protocol as defined in Figure 40 shall be used to implement the NMT service stop remote node.

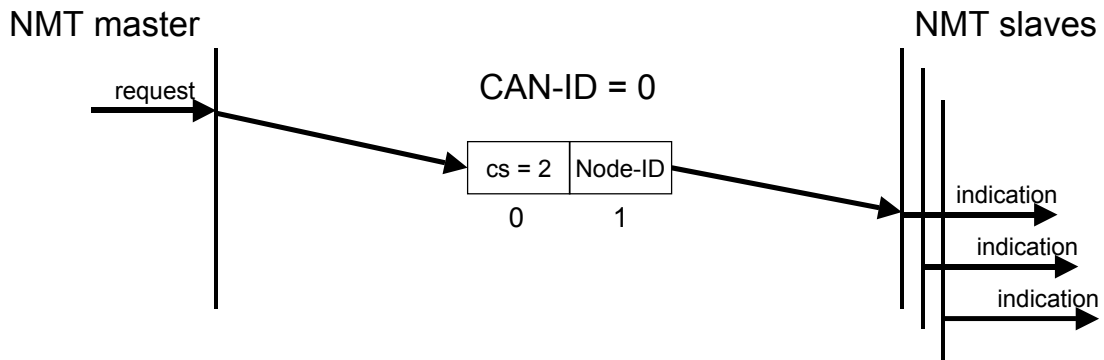

cs: NMT command specifier

2: stop

Figure 40: Protocol stop remote node

7.2.8.3.1.3 Protocol enter pre-operational

The protocol as defined in Figure 41 shall be used to implement the NMT service enter pre-operational.

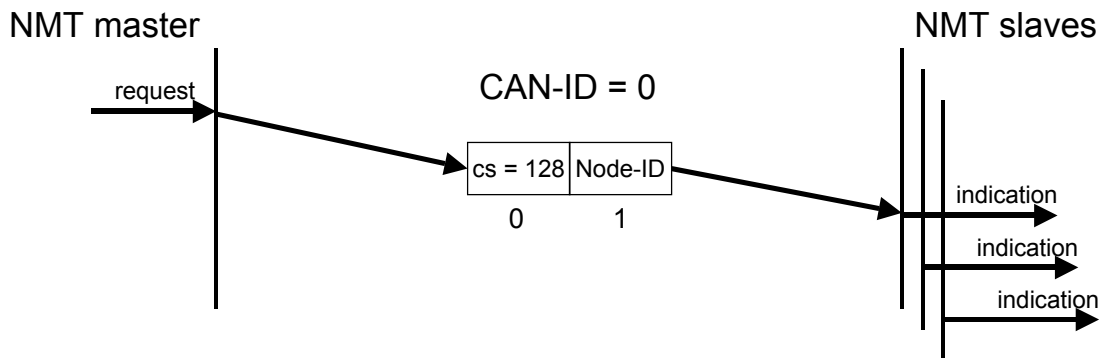

cs: NMT command specifier

128: enter pre-operational

Figure 41: Protocol enter pre-operational

7.2.8.3.1.4 Protocol reset node

The protocol as defined in Figure 42 shall be used to implement the NMT service reset node.

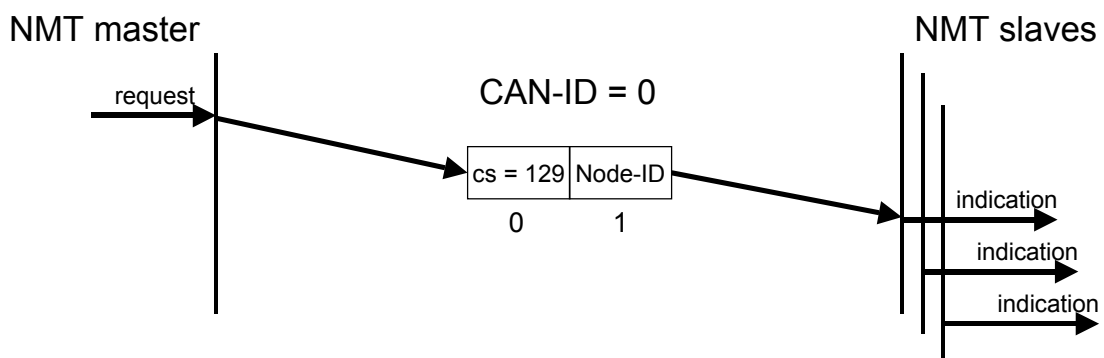

cs: NMT command specifier

129: reset node

Figure 42: Protocol reset node

7.2.8.3.1.5 Protocol reset communication

The protocol as defined in Figure 43 shall be used to implement the NMT service reset communication.

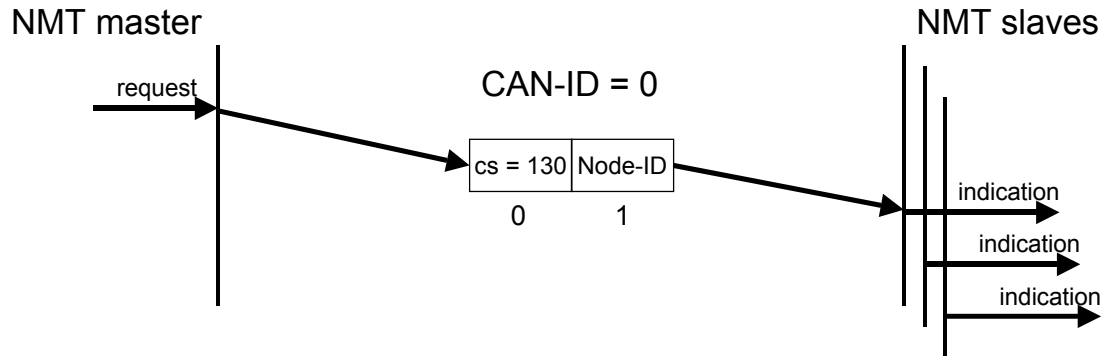

cs: NMT command specifier
130: reset communication

Figure 43: Protocol reset communication

7.2.8.3.2 Error Control Protocols

7.2.8.3.2.1 Protocol node guarding

The protocol as defined in Figure 44 shall be used to detect remote errors in the network. Each NMT slave serves one RTR for the node guarding protocol. This protocol implements the provider initiated error control services.

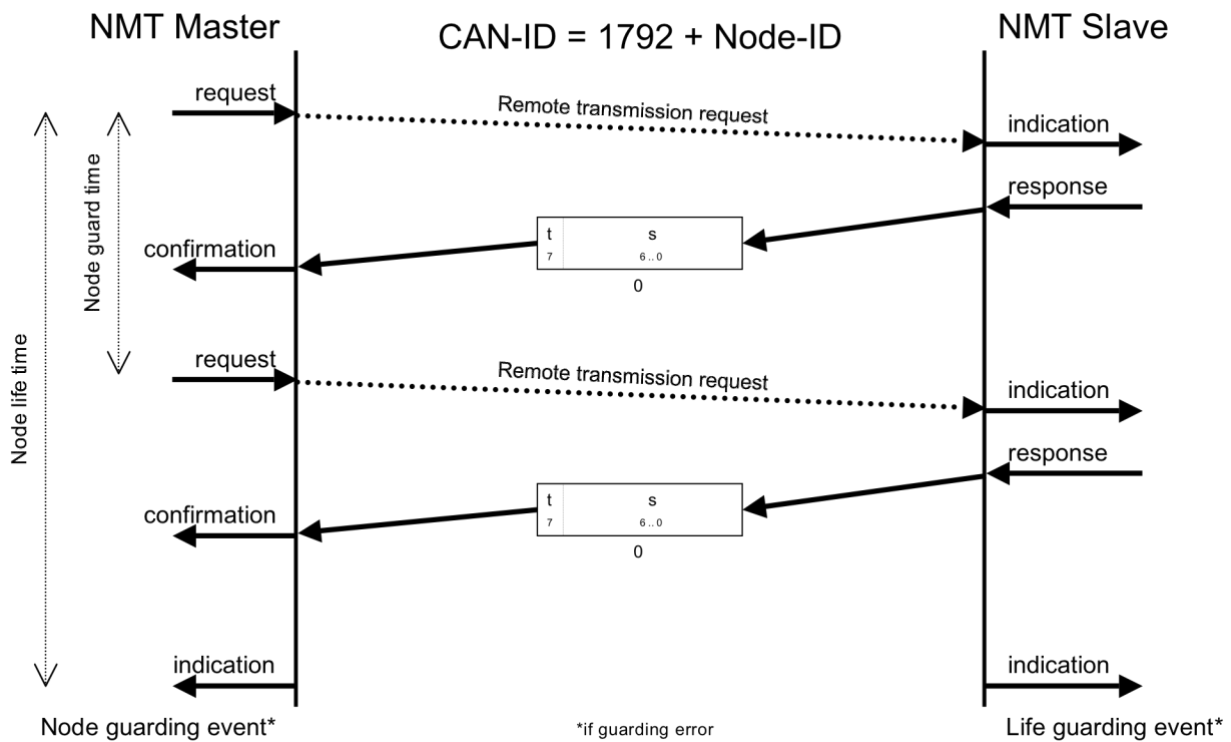

s: the state of the NMT slave

- 4: Stopped
- 5: Operational
- 127: Pre-operational

t: toggle bit. The value of this bit shall alternate between two consecutive responses from the NMT slave. The value of the toggle-bit of the first response after the guarding protocol becomes active shall be 0. The toggle bit in the guarding protocol shall be reset to 0 when the NMT sub-state reset communication is passed (no other change of NMT state resets the toggle bit). If a response is received with the same value of the toggle-bit as in the preceding response then the new response is handled as if it was not received.

Figure 44: Protocol node guarding

The NMT master polls each NMT slave at regular time intervals. This time-interval is called the guard time and may be different for each NMT slave. The response of the NMT slave contains the NMT state of that NMT slave. The node lifetime is given by the guard time multiplied by the lifetime factor. The node lifetime may be different for each NMT slave. If the NMT slave has not been polled during its lifetime, a remote node error is indicated through the NMT service life guarding event.

A remote node error is indicated through the NMT service node guarding event if

- The RTR is not confirmed within the node life time
- The reported NMT slave state does not match the expected state

If it has been indicated that a remote error has occurred and the errors in the guarding protocol have disappeared, it will be indicated that the remote error has been resolved through the NMT service node guarding event and the NMT service life guarding event.

For the guard time, and the life time factor there are default values specified at the appropriate object dictionary objects.

7.2.8.3.2.2 Protocol heartbeat

The heartbeat protocol as defined in Figure 45 defines an error control service without need for RTRs. A heartbeat producer transmits a heartbeat message cyclically. One or more heartbeat consumer receives the indication. The relationship between producer and consumer is configurable via the object dictionary. The heartbeat consumer guards the reception of the heartbeat within the heartbeat consumer time. If the heartbeat is not received within the heartbeat consumer time a heartbeat event will be generated.

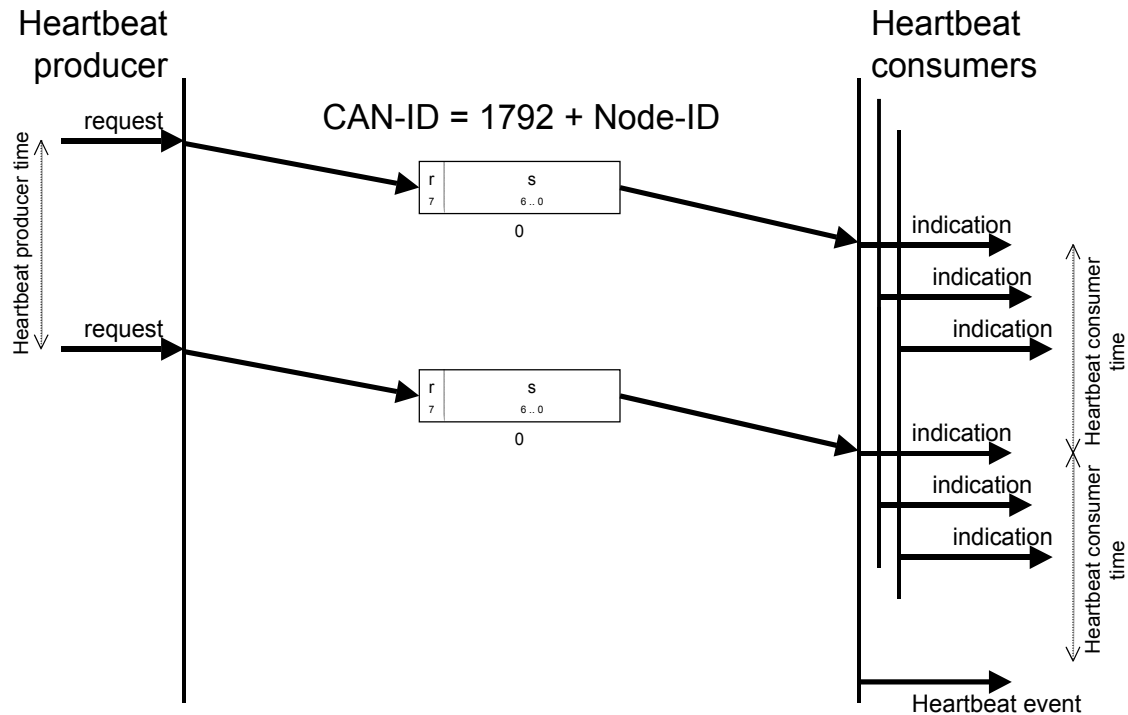

- **r**: reserved (always 0)
- **s**: the state of the heartbeat producer
 - 0: Boot-up
 - 4: Stopped
 - 5: Operational
 - 127: Pre-operational

Figure 45: Protocol heartbeat

If the heartbeat producer time is configured on a CANopen device the heartbeat protocol begins immediately. If a CANopen device starts with a value for the heartbeat producer time unequal to 0 the heartbeat protocol starts on the transition from the NMT state Initialisation to the NMT state Pre-operational. In this case the boot-up message is regarded as first heartbeat message. It is not allowed to use both error control mechanisms guarding protocol and heartbeat protocol on one NMT slave at the same time. If the heartbeat producer time is unequal 0 the heartbeat protocol is used.

7.2.8.3.3 Protocol boot-up

The protocol as defined in Figure 46 shall be used to signal that a NMT slave has entered the NMT state Pre-operational after the NMT state Initialising. The protocol uses the same CAN-ID as the error control protocols.

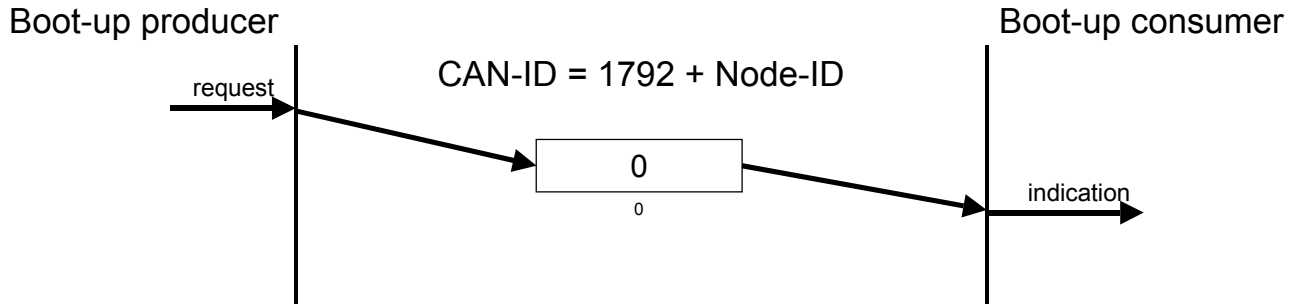

One data byte is transmitted with value 0.

Figure 46: Protocol boot-up

7.3 Network initialization and system boot-up

7.3.1 Simplified NMT startup

An example of a simplified NMT startup is shown in Figure 47. The definition of the process NMT startup does not fall into the scope of this specification.

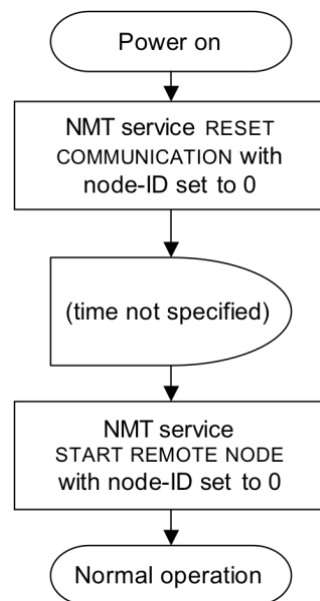

Figure 47: NMT startup simple

7.3.2 NMT state machine

7.3.2.1 Overview

In Figure 48 the NMT state diagram of a CANopen device is specified. CANopen devices enter the NMT state Pre-operational directly after finishing the CANopen devices initialization. During this NMT state CANopen device parameterization and CAN-ID-allocation via SDO (e.g. using a configuration tool) is possible. Then the CANopen devices may be switched directly into the NMT state Operational.

The NMT state machine determines the behavior of the communication function unit (see sub-clause 4.3). The coupling of the application state machine to the NMT state machine is CANopen device dependent and falls into the scope of device profiles and application profiles.

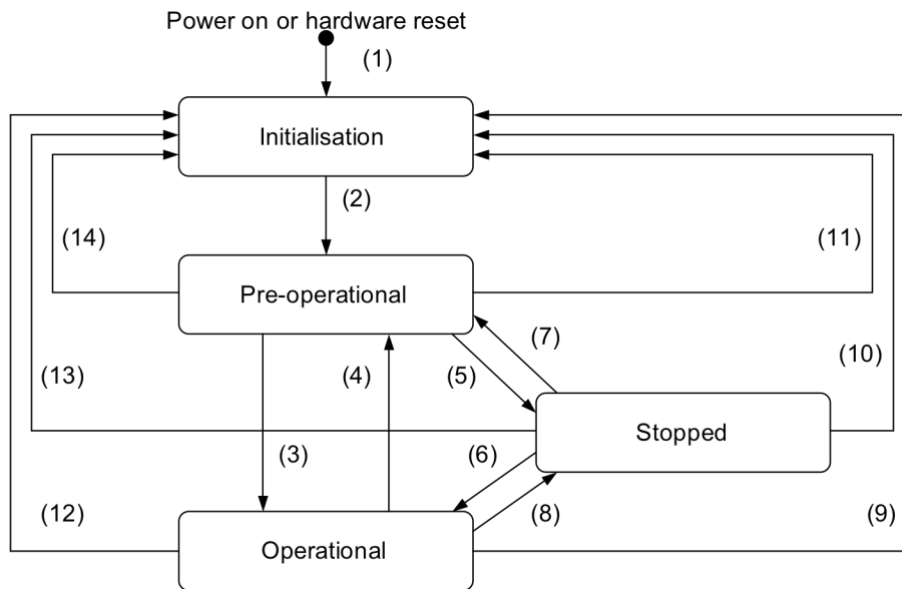

(1)	At Power on the NMT state initialisation is entered autonomously
(2)	NMT state Initialisation finished - enter NMT state Pre-operational automatically
(3)	NMT service start remote node indication or by local control
(4),(7)	NMT service enter pre-operational indication
(5),(8)	NMT service stop remote node indication
(6)	NMT service start remote node indication
(9),(10),(11)	NMT service reset node indication
(12),(13),(14)	NMT service reset communication indication

Figure 48: NMT state diagram of a CANopen device

7.3.2.2 NMT states

7.3.2.2.1 NMT state Initialisation

The NMT state initialisation shall be divided into three NMT sub-states (specified in Figure 49) in order to enable a complete or partial reset of a CANopen device.

- Initialising:** This is the first NMT sub-state the CANopen device enters after power-on or hardware reset. After finishing the basic CANopen device initialisation the CANopen device enters autonomously into the NMT sub-state reset application.
- Reset application:** In this NMT sub-state the parameters of the manufacturer-specific profile area and of the standardized device profile area are set to their power-on values. After setting of the power-on values the NMT sub-state reset communication is entered autonomously.
- Reset communication:** In this NMT sub-state the parameters of the communication profile area are set to their power-on values. After this the NMT state Initialisation is finished and the CANopen device executes the NMT service boot-up write and enters the NMT state Pre-operational.

Power-on values are the last stored parameters. If storing is not supported or has not been executed or if the reset was preceded by the command restore defaults (see clause 7.5.2.14), the power-on values are the default values according to the communication and device profile specifications.

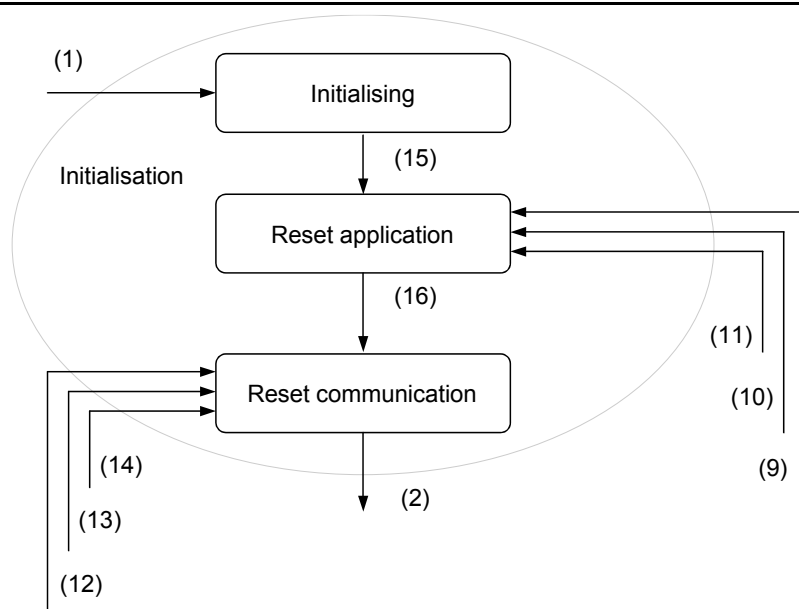

(1)	At power on the NMT state initialisation is entered autonomously
(2)	NMT state Initialisation finished - enter NMT state Pre-operational automatically
(12), (13), (14)	NMT service reset communication indication
(9), (10), (11)	NMT service reset node indication
(15)	NMT sub-state Initialization finished – NMT sub-state reset application is entered autonomously
(16)	NMT sub-state reset application is finished – NMT sub-state reset communication is entered autonomously

Figure 49: Structure of the NMT state Initialization

7.3.2.2.2 NMT state Pre-operational

In the NMT state Pre-operational, communication via SDOs is possible. PDOs do not exist, so PDO communication is not allowed. Configuration of PDOs, parameters and also the allocation of application objects (PDO mapping) may be performed by a configuration application.

The CANopen device may be switched into the NMT state Operational directly by sending the NMT service start remote node or by means of local control.

7.3.2.2.3 NMT state Operational

In the NMT state Operational all communication objects are active. Transitioning to the NMT state Operational creates all PDOs; the constructor uses the parameters as described in the object dictionary. Object dictionary access via SDO is possible. Implementation aspects or the application state machine however may require to limit the access to certain objects whilst being in the NMT state Operational, e.g. an object may contain the application program which cannot be changed during execution.

7.3.2.2.4 NMT state Stopped

By switching a CANopen device into the NMT state Stopped it is forced to stop the communication altogether (except node guarding and heartbeat, if active). Furthermore, this NMT state may be used to achieve certain application behavior. The definition of this behavior falls into the scope of device profiles and application profiles.

If there are EMCY messages triggered in this NMT state they are pending. The most recent active EMCY reason may be transmitted after the CANopen device transits into another NMT state.

NOTE: The error history may be read by accessing the object 1003_n, if implemented.

7.3.2.2.5 NMT states and communication object relation

Table 37 specifies the relation between NMT states and communication objects. Services on the listed communication objects may only be executed if the CANopen devices involved in the communication are in the appropriate NMT states.

Table 37: NMT states and communication objects

	Pre-operational	Operational	Stopped
PDO		X	
SDO	X	X	
SYNC	X	X	
TIME	X	X	
EMCY	X	X	
Node control and error control	X	X	X

7.3.2.3 NMT state transitions

NMT state transitions are caused by

- reception of an NMT service used for node control services,
- hardware reset, or
- node control services locally initiated by application events, defined by device profiles and application profiles

7.3.3 Generic pre-defined connection set

In order to reduce configuration effort for simple networks a CAN-ID allocation scheme is defined. These CAN-IDs shall be available in the NMT state Pre-operational directly after the NMT state Initialization (if no modifications have been stored). The objects SYNC, TIME, EMCY write and PDO may be deleted and re-created with new CAN-IDs by means of dynamic distribution. A CANopen device shall provide the corresponding CAN-IDs only for the supported communication objects.

The CAN-ID-allocation scheme (defined in Table 38 and Table 39) consists of a functional part, which determines the object priority and a node-ID part, which allows to distinguish between CANopen devices of the same functionality. This allows a peer-to-peer communication between a single master CANopen device and up to 127 NMT slave CANopen devices. It also supports the broadcasting of non-confirmed NMT, SYNC and TIME messages. Broadcasting is indicated by a node-ID of zero.

The generic pre-defined connection set supports one emergency object, one SDO, at maximum 4 RPDOs and 4 TPDOs and the NMT objects.

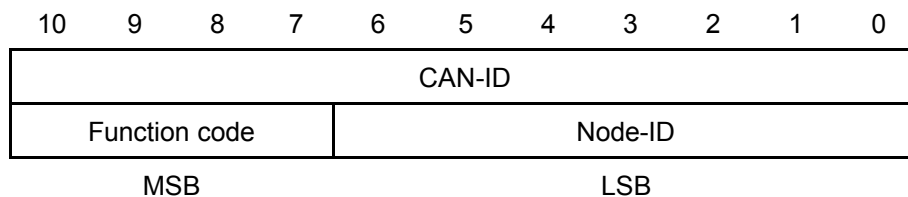

Figure 50: CAN-ID-allocation scheme for the generic pre-defined connection set

Table 38 and Table 39 show the supported objects and their allocated CAN-IDs.

Table 38: Broadcast objects of the generic pre-defined connection set

COB	Function code	resulting CAN-ID
NMT	0000 _b	0 (000 _h)
SYNC	0001 _b	128 (080 _h)
TIME	0010 _b	256 (100 _h)

Table 39: Peer-to-peer objects of the generic pre-defined connection set

COB	Function code	Resulting CAN-IDs
EMCY	0001 _b	129 (081 _h) – 255 (0FF _h)
PDO1 (tx)	0011 _b	385 (181 _h) – 511 (1FF _h)
PDO1 (rx)	0100 _b	513 (201 _h) – 639 (27F _h)
PDO2 (tx)	0101 _b	641 (281 _h) – 767 (2FF _h)
PDO2 (rx)	0110 _b	769 (301 _h) – 895 (37F _h)
PDO3 (tx)	0111 _b	897 (381 _h) – 1023 (3FF _h)
PDO3 (rx)	1000 _b	1025 (401 _h) – 1151 (47F _h)
PDO4 (tx)	1001 _b	1153 (481 _h) – 1279 (4FF _h)
PDO4 (rx)	1010 _b	1281 (501 _h) – 1407 (57F _h)
SDO (tx)	1011 _b	1409 (581 _h) – 1535 (5FF _h)
SDO (rx)	1100 _b	1537 (601 _h) – 1663 (67F _h)
NMT error control	1110 _b	1793 (701 _h) – 1919 (77F _h)

Table 39 is seen from the CANopen devices point of view.

The generic pre-defined connection set always applies to the CAN base frame with 11-bit CAN-ID, even if CAN extended frames are present in the network.

The generic pre-defined connection set shall apply for all CANopen devices that follow a certain device profile and do not follow any application profile.

7.3.4 Specific pre-defined connection set

The specific pre-defined connection set shall replace the generic pre-defined connection set for CANopen devices that follow an application profile. The definition of the specific pre-defined connection set does not fall into the scope of this specification; it falls into the scope of the appropriate application profile.

7.3.5 Restricted CAN-IDs

Any CAN-ID listed in Table 40 is of restricted use. Such a restricted CAN-ID shall not be used as a CAN-ID by any configurable communication object, neither for SYNC, TIME, EMCY, PDO, and SDO.

Table 40: Restricted CAN-IDs

CAN-ID	used by COB
0 (000 _h)	NMT
1 (001 _h) – 127 (07F _h)	reserved
257 (101 _h) – 384 (180 _h)	reserved
1409 (581 _h) – 1535 (5FF _h)	default SDO (tx)
1537 (601 _h) – 1663 (67F _h)	default SDO (rx)
1760 (6E0 _h) – 1791 (6FF _h)	reserved
1793 (701 _h) – 1919 (77F _h)	NMT Error Control
2020 (780 _h) – 2047 (7FF _h)	reserved

7.4 Object dictionary

7.4.1 General structure

The overall layout of the standard object dictionary is specified in Table 41.

Table 41: Object dictionary structure

Index	Object
0000 _h	not used
0001 _h – 001F _h	Static data types
0020 _h – 003F _h	Complex data types
0040 _h – 005F _h	Manufacturer-specific complex data types
0060 _h – 025F _h	Device profile specific data types
0260 _h – 03FF _h	reserved
0400 _h – 0FFF _h	reserved
1000 _h – 1FFF _h	Communication profile area
2000 _h – 5FFF _h	Manufacturer-specific profile area
6000 _h – 67FF _h	Standardized profile area 1 st logical device
6800 _h – 6FFF _h	Standardized profile area 2 nd logical device
7000 _h – 77FF _h	Standardized profile area 3 rd logical device
7800 _h – 7FFF _h	Standardized profile area 4 th logical device
8000 _h – 87FF _h	Standardized profile area 5 th logical device
8800 _h – 8FFF _h	Standardized profile area 6 th logical device
9000 _h – 97FF _h	Standardized profile area 7 th logical device
9800 _h – 9FFF _h	Standardized profile area 8 th logical device
A000 _h – AFFF _h	Standardized network variable area
B000 _h – BFFF _h	Standardized system variable area
C000 _h – FFFF _h	reserved

The object dictionary contains a maximum of 65.536 objects that shall be addressed through a 16-bit index and up to 256 sub-indices per object, which shall be addressed through an 8-bit sub-index.

The static data types at indices from 0001_h to 001F_h shall contain type definitions for standard data types like BOOLEAN, INTEGER, UNSIGNED, floating point, string, etc.

Complex data types at indices from 0020_h to 003F_h shall be pre-defined structures that are composed of standard data types and are common to all CANopen devices.

Manufacturer-specific complex data types at indices from 0040_h to 005F_h shall be structures composed of standard data types but are specific to a particular CANopen device.

Device profiles may define additional data types specific to their device type. The static data types and the complex data types defined by the device profile shall be listed at indices from 0060_h to 025F_h.

A CANopen device may optionally provide the structure of the supported complex data types (indices from 0020_h to 005F_h and from 0060_h to 025F_h) at read access to the corresponding index. Sub-index 0 then shall provide the highest sub-index supported at this index, and the following sub-indices shall contain the data type encoded as UNSIGNED16 according to Table 44.

The communication profile area at indices from 1000_h to 1FFF_h shall contain the communication specific parameters. These objects are common to all CANopen devices.

The standardized profile area at indices from 6000_h to 9FFF_h shall contain all data objects common to a class of CANopen devices that may be read or written via the network. The device profiles may use objects from 6000_h to 9FFF_h to describe parameters and functionality.

The object dictionary concept caters for optional features, which means a manufacturer may not provide certain extended functionality on his CANopen devices but if he wishes to do so he shall do it in a pre-defined fashion. Space is left in the object dictionary at indices from 2000_h to 5FFF_h for truly manufacturer-specific functionality.

The network variables at indices from A000_h to AFFF_h shall contain input variables and output variables, which are part of a programmable CANopen device. The definition of these network variables does not fall into the scope of this document and are part of future profiles and frameworks.

The system variables at indices from B000_h to BFFF_h shall contain input variables and output variables, which are part of an underlying CANopen network in a hierarchical sense. The definition of these system variables does not fall into the scope of this document and are part of future profiles and frameworks.

7.4.2 Index and sub-index usage

A 16-bit index is used to address all objects within the object dictionary. In case of a simple variable the index references the value of this variable directly. In case of records and arrays however, the index addresses the whole data structure.

To allow individual elements of structures of data to be accessed via the network a sub-index is defined. For single object dictionary objects such as an UNSIGNED8, BOOLEAN, INTEGER32 etc. the value for the sub-index is always 00_h. For complex object dictionary objects such as arrays or records with multiple data fields the sub-index references fields within a data-structure pointed to by the main index. The fields accessed by the sub-index may be of differing data types.

7.4.3 Object code usage

The object code shall denote what kind of object is at that particular index within the object dictionary. The following definitions are used:

Table 42: Object Dictionary object definitions

Object name	Comments	Object code
NULL	An object with no data fields	00 _h
DOMAIN	Large variable amount of data e.g. executable program code	02 _h
DEFTYPE	Denotes a type definition such as a BOOLEAN, UNSIGNED16, FLOAT and so on	05 _h
DEFSTRUCT	Defines a new record type e.g. the PDO mapping structure at 21 _h	06 _h
VAR	A single value such as an UNSIGNED8, BOOLEAN, FLOAT, INTEGER16, VISIBLE STRING etc.	07 _h
ARRAY	A multiple data field object where each data field is a simple variable of the SAME basic data type e.g. array of UNSIGNED16 etc. Sub-index 0 is of UNSIGNED8 and therefore not part of the ARRAY data	08 _h
RECORD	A multiple data field object where the data fields may be any combination of simple variables. Sub-index 0 is of UNSIGNED8 and sub-index 255 is of UNSIGNED32 and therefore not part of the RECORD data	09 _h

7.4.4 Data type usage

The data type information of an object includes the following pre-defined types: BOOLEAN, FLOAT, UNSIGNED, INTEGER, VISIBLE/OCTET STRING, TIME_OF_DAY, TIME_DIFFERENCE and DOMAIN (see sub-clause 7.1). It also includes the pre-defined complex data type PDO mapping and may also include others that are either manufacturer-specific, device profile specific or application profile specific. It is not possible to define records of records, arrays of records or records with arrays as fields of that record. In the case where an object is an array or a record the sub-index is used to reference one data field within the object.

7.4.5 Access usage

The Attribute defines the access rights for a particular object. The viewpoint is from the network into the CANopen device.

It shall be one of the following:

Table 43: Access attributes for data objects

Attribute	Description
rw	read and write access
wo	write only access
ro	read only access
const	read only access, value is constant The value may change in NMT state Initialisation. The value shall not change in the NMT states pre-operation, operational and stopped.

7.4.6 Category and entry category usage

The category and entry category defines whether the object is mandatory, optional or conditional. A mandatory object shall be implemented on a CANopen device. An optional object may be implemented on a CANopen device. The support of certain objects or features however may require the implementation of related objects. In this case, the relations are described in the detailed object specification and the object is defined as a conditional object.

7.4.7 Data type entry usage

7.4.7.1 General

The static data types are placed in the object dictionary for definition purposes only. Indices in the range from 0001_h to 0007_h, 0010_h, from 0012_h to 0016_h, and from 0018_h to 001B_h may be mapped in order to define the appropriate space in the RPDO as not being used by this CANopen device (do not care). Other objects of the object code DEFTYPE and DEFSTRUCT shall not be mapped into RPDOs.

The order of the data types is as follows:

Table 44: Object dictionary data types

Index	Object	Name
0001 _h	DEFTYPE	BOOLEAN
0002 _h	DEFTYPE	INTEGER8
0003 _h	DEFTYPE	INTEGER16
0004 _h	DEFTYPE	INTEGER32
0005 _h	DEFTYPE	UNSIGNED8
0006 _h	DEFTYPE	UNSIGNED16
0007 _h	DEFTYPE	UNSIGNED32
0008 _h	DEFTYPE	REAL32
0009 _h	DEFTYPE	VISIBLE_STRING
000A _h	DEFTYPE	OCTET_STRING
000B _h	DEFTYPE	UNICODE_STRING

Index	Object	Name
000C _h	DEFTYPE	TIME_OF_DAY
000D _h	DEFTYPE	TIME_DIFFERENCE
000E _h	reserved	
000F _h	DEFTYPE	DOMAIN
0010 _h	DEFTYPE	INTEGER24
0011 _h	DEFTYPE	REAL64
0012 _h	DEFTYPE	INTEGER40
0013 _h	DEFTYPE	INTEGER48
0014 _h	DEFTYPE	INTEGER56
0015 _h	DEFTYPE	INTEGER64
0016 _h	DEFTYPE	UNSIGNED24
0017 _h	reserved	
0018 _h	DEFTYPE	UNSIGNED40
0019 _h	DEFTYPE	UNSIGNED48
001A _h	DEFTYPE	UNSIGNED56
001B _h	DEFTYPE	UNSIGNED64
001C _h – 001F _h	reserved	
0020 _h	DEFSTRUCT	PDO_COMMUNICATION_PARAMETER
0021 _h	DEFSTRUCT	PDO_MAPPING
0022 _h	DEFSTRUCT	SDO_PARAMETER
0023 _h	DEFSTRUCT	IDENTITY
0024 _h – 003F _h	reserved	
0040 _h – 005F _h	DEFSTRUCT	Manufacturer-specific Complex Data types
0060 _h – 007F _h	DEFTYPE	Device profile specific Standard Data types 1 st logical device
0080 _h – 009F _h	DEFSTRUCT	Device profile specific Complex Data types 1 st logical device
00A0 _h – 00BF _h	DEFTYPE	Device profile specific Standard Data types 2 nd logical device
00C0 _h – 00DF _h	DEFSTRUCT	Device profile specific Complex Data types 2 nd logical device
00E0 _h – 00FF _h	DEFTYPE	Device profile specific Standard Data types 3 rd logical device
0100 _h – 011F _h	DEFSTRUCT	Device profile specific Complex Data types 3 rd logical device
0120 _h – 013F _h	DEFTYPE	Device profile specific Standard Data types 4 th logical device
0140 _h – 015F _h	DEFSTRUCT	Device profile specific Complex Data types 4 th logical device
0160 _h – 017F _h	DEFTYPE	Device profile specific Standard Data types 5 th logical device
0180 _h – 019F _h	DEFSTRUCT	Device profile specific Complex Data types 5 th logical device
01A0 _h – 01BF _h	DEFTYPE	Device profile specific Standard Data types 6 th logical device

Index	Object	Name
01C0 _h – 01DF _h	DEFSTRUCT	Device profile specific Complex Data types 6 th logical device
01E0 _h – 01FF _h	DEFTYPE	Device profile specific Standard Data types 7 th logical device
0200 _h – 021F _h	DEFSTRUCT	Device profile specific Complex Data types 7 th logical device
0220 _h – 023F _h	DEFTYPE	Device profile specific Standard Data types 8 th logical device
0240 _h – 025F _h	DEFSTRUCT	Device profile specific Complex Data types 8 th logical device

The data type representations used is detailed in sub-clause 7.1. Every CANopen device does not need to support all the defined data types. A CANopen device may only support the data types it uses with the objects in the range from 1000_h to AFFF_h.

The pre-defined complex data types are placed after the standard data types. These pre-defined complex data types are defined in sub-clause 7.4.8.

A CANopen device may optionally provide the length of the standard data types encoded as UNSIGNED32 at read access to the object entry that refers to the data type. E.g. index 000C_h (TIME_OF_DAY) contains the value 0000 0030_h = 48_d as the data type TIME_OF_DAY is encoded using a bit sequence of 48 bit. If the length is variable (e.g. 000F_h = Domain), the object entry contains 0000 0000_h.

For the supported complex data types a CANopen device may optionally provide the structure of that data type at read access to the corresponding data type index. Sub-index 00_h then provides the highest sub-index supported at this index not counting sub-indices 00_h and FF_h and the following sub-indices contain the data type according to Table 44 encoded as UNSIGNED16 (UNSIGNED8 is used by old implementations). The object at index 0020_h describing the structure of the PDO communication parameter then looks as follows (see also objects from 1400_h to 15FF_h):

Table 45: complex data type example

Sub-index	Value	(Description)
00 _h	04 _h	(4 sub indices follow)
01 _h	0007 _h	(UNSIGNED32)
02 _h	0005 _h	(UNSIGNED8)
03 _h	0006 _h	(UNSIGNED16)
04 _h	0005 _h	(UNSIGNED8)

Standard (simple) and complex manufacturer-specific data types may be distinguished by attempting to read sub-index 01_h: At a complex data type the device returns a value and sub-index 00_h contains the number of sub-indices that follow, at a standard data type the device aborts the SDO transfer as no sub-index 01_h available.

Note that some object entries of data type UNSIGNED32 have the character of a structure (e.g. PDO COB-ID, see Figure 67).

7.4.7.2 Organization of structured object dictionary entries

If an object dictionary object contains several sub-indices, then sub-index 00_h describes the highest available sub-index that follows, not considering FF_h. This object entry is encoded as UNSIGNED8.

Sub-index FF_h describes the structure of the object by providing the data type and the object type of the object. It is encoded as UNSIGNED32 and organized as follows:

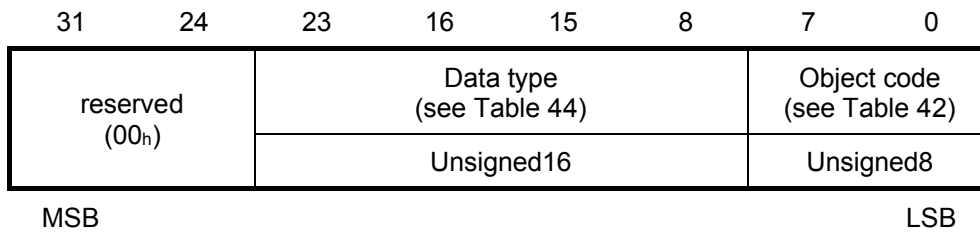

Figure 51: Structure sub-index FF_h

It is optional to support sub-index FF_h. If it is supported throughout the object dictionary and the structure of the complex data types is provided as well, it enables one to upload the entire structure of the object dictionary.

7.4.8 Specification of pre-defined complex data types

This section describes the structure of the pre-defined complex data types used for communication. The value range and the meaning are explained at the detailed description of the objects using these types.

7.4.8.1 PDO communication parameter record specification

Table 46 specifies the PDO communication parameter record.

Table 46: PDO communication parameter record

Index	Sub-index	Name	Data type
0020 _h	00 _h	Highest sub-index supported	UNSIGNED8
	01 _h	COB-ID	UNSIGNED32
	02 _h	Transmission type	UNSIGNED8
	03 _h	Inhibit time	UNSIGNED16
	04 _h	reserved	UNSIGNED8
	05 _h	Event timer	UNSIGNED16
	06 _h	SYNC start value	UNSIGNED8

7.4.8.2 PDO mapping parameter record specification

Table 47 specifies the PDO mapping parameter record.

Table 47: PDO mapping parameter record

Index	Sub-index	Name	Data type
0021 _h	00 _h	Number of mapped objects in PDO	UNSIGNED8
	01 _h	1st object to be mapped	UNSIGNED32
	02 _h	2 nd object to be mapped	UNSIGNED32
	⋮⋮⋮⋮	⋮⋮⋮⋮⋮⋮	⋮⋮⋮⋮
	40 _h	64 th object to be mapped	UNSIGNED32

7.4.8.3 SDO parameter record specification

Table 48 specifies the SDO parameter record.

Table 48: SDO parameter record

Index	Sub-index	Name	Data type
0022 _h	00 _h	Highest sub-index supported	UNSIGNED8
	01 _h	COB-ID client -> server	UNSIGNED32
	02 _h	COB-ID server -> client	UNSIGNED32
	03 _h	Node-ID of SDO's client resp. server	UNSIGNED8

7.4.8.4 Identity record specification

Table 49 specifies the identity record.

Table 49: Identity record

Index	Sub-index	Name	Data type
0023 _h	00 _h	Highest sub-index supported	UNSIGNED8
	01 _h	Vendor-ID	UNSIGNED32
	02 _h	Product code	UNSIGNED32
	03 _h	Revision number	UNSIGNED32
	04 _h	Serial number	UNSIGNED32

7.4.8.5 OS debug record specification

Table 50 specifies the OS debug record.

Table 50: OS debug record

Index	Sub-index	Name	Data type
0024 _h	00 _h	Highest sub-index supported	UNSIGNED8
	01 _h	Command	OCTET_STRING
	02 _h	Status 00 _h - Command completed – no error 01 _h - Command completed – error 02 _h - reserved ::: FE _h - reserved FF _h - Command executing	UNSIGNED8
	03 _h	Reply	OCTET_STRING

7.4.8.6 OS Command record specification

Table 51 specifies the OS command record.

Table 51: OS command record

Index	Sub-index	Name	Data type
0025 _h	00 _h	Highest sub-index supported	UNSIGNED8
	01 _h	Command	OCTET_STRING
	02 _h	Status 00 _h - Command completed – no error – no reply 01 _h - Command completed – no error – reply 02 _h - Command completed – error – no reply 03 _h - Command completed – error – reply 04 _h - reserved : : : : FE _h - reserved FF _h - Command executing	UNSIGNED8
	03 _h	Reply	OCTET_STRING

7.5 Communication profile specification

7.5.1 Object and entry description specification

The structure of the object dictionary object entries is described in the following manner: All device profiles, interface profiles and application profiles based on this communication profile uses the object and entry description as specified in Table 52 and Table 53.

Table 52: Format of an object description

OBJECT DESCRIPTION

Index	Profile index number
Name	Name of parameter
Object code	Variable classification
Data type	Data type classification
Category	Optional or Mandatory

The object code shall be one of those defined in object description Table 52 above. For better readability, the object description additionally contains the symbolic object name.

Table 53: Object value description format

ENTRY DESCRIPTION

Sub-index	Number of the sub- being described
Description	Descriptive name of the sub-index (field only used for arrays, records and structures)
Data type	Data type classification (field only used for records and structures)
Entry category	Specifies if the object entry is optional or mandatory or conditional in case the object is present
Access	Read only (ro) or read/write (rw) or write only (wo) or const
PDO mapping	<p>Shall define if this object shall be mapped to a PDO. Description:</p> <p>Optional: Object may be mapped into a PDO</p> <p>Default: Object is part of the default mapping (see device profile or application profile)</p> <p>TPDO: Object may be mapped into a TPDO and shall not be mapped into a RPDO</p> <p>RPDO: Object may be mapped into a RPDO and shall not be mapped into a TPDO</p> <p>No: Object shall not be mapped into a PDO</p>
Value range	range of possible values, or name of data type for full range
Default value	<p>No: no default value applicable.</p> <p>Profile-specific: default value of an object shall be defined in a profile.</p> <p>Manufacturer-specific: default value of an object shall be defined by the manufacturer of the CANopen device.</p> <p>Value: default value of an object after CANopen device initialisation</p>

For simple variables the Value definition appears once without entry category. For complex data types the Value definition shall be defined for each element (sub-index).

7.5.2 Detailed specification of communication profile specific objects**7.5.2.1 Object 1000_h: Device type**

This object shall provide information about the device type. The object describes the type of the logical device and its functionality. It shall be composed of a 16-bit field that describes the device profile or the application profile that is used and a second 16-bit field, which gives additional information about optional functionality of the logical device. The additional information parameter is device profile specific and application profile specific. Its specification does not fall within the scope of this specification; it is defined in the appropriate device profile and application profile.

VALUE DEFINITION

The value 0000_h for the device profile number shall indicate a logical device that does not follow a standardized profile. In this case the additional information shall be 0000_h (if no further logical device is implemented) or FFFF_h (if a further logical device is implemented).

For multiple logical device modules the additional information parameter shall be FFFF_h and the device profile number referenced by object 1000_h shall be the profile of the first logical device in the object dictionary. All other profiles of a multiple logical device module shall identify their profiles at objects 67FF_h + x * 800_h with x = internal number of the logical device (from 1 to 8) minus 1. These objects shall describe the device type of the preceding logical device, having the very same value definition as object 1000_h.

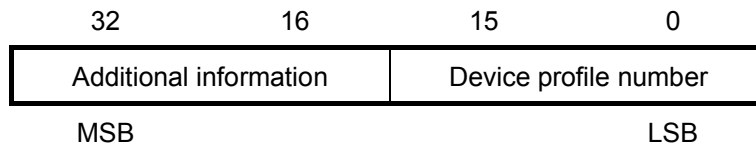

Figure 52: Structure of the device type parameter

OBJECT DESCRIPTION

Index	1000 _h
Name	Device type
Object code	VAR
Data type	UNSIGNED32
Category	Mandatory

ENTRY DESCRIPTION

Sub-index	00 _h
Access	ro
PDO mapping	No
Value range	See <i>value definition</i>
Default value	Profile- or manufacturer-specific

7.5.2.2 Object 1001_h: Error register

This object shall provide error information. The CANopen device maps internal errors into this object. It is a part of an emergency object.

VALUE DEFINITION

Table 54: Structure of the error register

Bit	M/O	Meaning
0	M	Generic error
1	O	Current
2	O	Voltage
3	O	Temperature
4	O	Communication error (overrun, error state)
5	O	Device profile specific
6	O	reserved (always 0 _b)
7	O	manufacturer-specific

If a specific error occurs the corresponding bit shall be set to 1_b. The generic error bit shall be supported. The other bits may be supported. The generic error shall be signaled at any error situation.

OBJECT DESCRIPTION

Index	1001 _h
Name	Error register
Object code	VAR
Data type	UNSIGNED8
Category	Mandatory

ENTRY DESCRIPTION

Sub-index	00 _h
Access	ro
PDO mapping	Optional
Value range	See <i>value definition</i>
Default value	No

7.5.2.3 Object 1002_h: Manufacturer status register

This object shall provide a common status register for manufacturer-specific purposes. In this specification only the size and the location of this object are defined.

OBJECT DESCRIPTION

Index	1002 _h
Name	Manufacturer status register
Object code	VAR
Data type	UNSIGNED32
Category	Optional

ENTRY DESCRIPTION

Sub-index	00 _h
Access	ro
PDO mapping	Optional
Value range	UNSIGNED32
Default value	No

7.5.2.4 Object 1003_h: Pre-defined error field

This object shall provide the errors that occurred on the CANopen device and were signaled via the emergency object. In doing so it provides an error history.

VALUE DEFINITION

- The object entry at sub-index 00_h shall contain the number of actual errors that are recorded in the array starting at sub-index 01_h.
NOTE: If no error is present the value of sub-index 00_h is 00_h and a read access to sub-index 01_h is responded with an SDO abort message (abort code: 0800 0024_h or 0800 0000_h).
- Every new error shall be stored at sub-index 01_h; older errors shall be moved to the next higher sub-index.
- Writing 00_h to sub-index 00_h shall delete the entire error history (empties the array). Other values than 00_h are not allowed and shall lead to an abort message (error code: 0609 0030_h).

- The error numbers are of type UNSIGNED32 (see Table 26) and are composed of a 16-bit error code and a 16-bit additional error information field, which is manufacturer-specific. The error code shall be contained in the lower 2 bytes (LSB) and the additional information shall be included in the upper 2 bytes (MSB). If this object is supported it shall consist of two object entries at least. The length entry on sub-index 00_h and at least one error entry at sub-index 01_h.

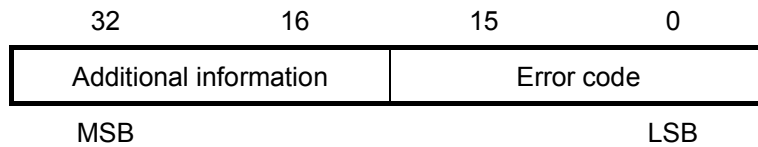

Figure 53: Structure of the pre-defined error field

OBJECT DESCRIPTION

Index	1003 _h
Name	Pre-defined error field
Object code	ARRAY
Data type	UNSIGNED32
Category	Optional

ENTRY DESCRIPTION

Sub-index	00 _h
Description	Number of errors
Entry category	Mandatory
Access	rw
PDO mapping	No
Value range	00 _h to FE _h
Default value	00 _h

Sub-index	01 _h
Description	Standard error field
Entry category	Mandatory
Access	ro
PDO mapping	No
Value range	UNSIGNED32
Default value	No

Sub-index	02 _h to FE _h
Description	Standard error field
Entry category	Optional
Access	ro
PDO mapping	No
Value range	UNSIGNED32
Default value	No

7.5.2.5 Object 1005_h: COB-ID SYNC message

This object shall indicate the configured COB-ID of the synchronization object (SYNC). Further, it defines whether the CANopen device generates the SYNC. The structure of this object is specified in Figure 54 and Table 55.

VALUE DEFINITION

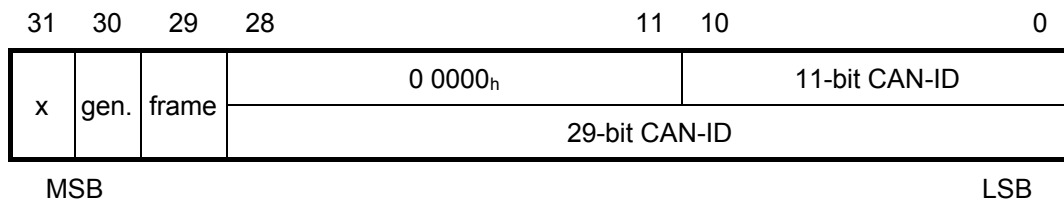

Figure 54: Structure of SYNC COB-ID

Table 55: Description of SYNC COB-ID

Bit(s)	Value	Description
x	x	do not care
gen.	0 _b	CANopen device does not generate SYNC message
	1 _b	CANopen device generates SYNC message
frame	0 _b	11-bit CAN-ID valid (CAN base frame)
	1 _b	29-bit CAN-ID valid (CAN extended frame)
29-bit CAN-ID	x	29-bit CAN-ID of the CAN extended frame
11-bit CAN-ID	x	11-bit CAN-ID of the CAN base frame

Bits 29 (frame) and bit 30 (gen.) may be static (not changeable). If a CANopen device is not able to generate SYNC messages, an attempt to set bit 30 (gen.) to 1_b is responded with the SDO abort transfer service (abort code: 0609 0030_h). CANopen devices supporting the CAN base frame type only, an attempt to set bit 29 (frame) to 1_b is responded with the SDO abort transfer service (abort code: 0609 0030_h). The first transmission of SYNC object starts within 1 sync cycle after setting bit 30 to 1_b. By setting bit 30 to 1_b while the synchronous counter overflow value is greater than 0 the first SYNC message shall start with the counter reset to 1. It is not allowed to change bits 0 to 29, while the object exists (bit 30 = 1_b).

OBJECT DESCRIPTION

Index	1005 _h
Name	COB-ID SYNC
Object code	VAR
Data type	UNSIGNED32
Category	Conditional; Mandatory, if PDO communication on a synchronous base is supported

ENTRY DESCRIPTION

Sub-index	00 _h
Access	rw; const, if the COB-ID is not changeable
PDO mapping	No
Value range	See <i>value definition</i>
Default value	0000 0080 _h or 8000 0080 _h

7.5.2.6 Object 1006_h: Communication cycle period

This object shall provide the communication cycle period. This period defines the SYNC interval.

VALUE DEFINITION

The value shall be given in multiple of μs . If the value is set to 0000 0000_h the transmission of SYNC messages shall be disabled. By changing the value from 0000 0000_h and the synchronous counter overflow value is greater than 0 the first SYNC message shall start with the counter value reset to 1.

The transmission of SYNC messages shall start within one communication cycle period as given by the value after it is set to the new value.

OBJECT DESCRIPTION

Index	1006 _h
Name	Communication cycle period
Object code	VAR
Data type	UNSIGNED32
Category	Conditional; Mandatory for SYNC producers

ENTRY DESCRIPTION

Sub-index	00 _h
Access	rw
PDO mapping	No
Value range	UNSIGNED32
Default value	0000 0000 _h

7.5.2.7 Object 1007_h: Synchronous window length

This object shall indicate the configured the length of the time window for synchronous PDOs.

If the synchronous window length expires all synchronous TPDOs may be discarded and an EMCY message may be transmitted; all synchronous RPDOs may be discarded until the next SYNC message is received. Synchronous RPDO processing is resumed with the next SYNC message.

VALUE DEFINITION

The value is given in multiple of μs . If the value is set to 0000 0000_h the synchronous window shall be disabled.

OBJECT DESCRIPTION

Index	1007 _h
Name	Synchronous window length
Object code	VAR
Data type	UNSIGNED32
Category	Optional

ENTRY DESCRIPTION

Sub-index	00 _h
Access	rw
PDO mapping	No
Value range	UNSIGNED32
Default value	0000 0000 _h

7.5.2.8 Object 1008_h: Manufacturer device name

This object shall provide the name of the device as given by the manufacturer.

OBJECT DESCRIPTION

Index	1008 _h
Name	Manufacturer device name
Object code	VAR
Data type	VISIBLE_STRING
Category	Optional

ENTRY DESCRIPTION

Sub-index	00 _h
Access	const
PDO mapping	No
Value range	VISIBLE_STRING
Default value	Manufacturer-specific

7.5.2.9 Object 1009_h: Manufacturer hardware version

This object shall provide the manufacturer hardware version description.

OBJECT DESCRIPTION

Index	1009 _h
Name	Manufacturer hardware version
Object code	VAR
Data type	VISIBLE_STRING
Category	Optional

ENTRY DESCRIPTION

Sub-index	00 _h
Access	const
PDO mapping	No
Value range	VISIBLE_STRING
Default value	Manufacturer-specific

7.5.2.10 Object 100A_h: Manufacturer software version

This object shall provide the manufacturer software version description.

OBJECT DESCRIPTION

Index	100A _h
Name	Manufacturer software version
Object code	VAR
Data type	VISIBLE_STRING
Category	Optional

ENTRY DESCRIPTION

Sub-index	00 _h
Access	const
PDO mapping	No
Value range	VISIBLE_STRING
Default value	Manufacturer-specific

7.5.2.11 Object 100C_h: Guard time

The objects at index 100C_h and 100D_h shall indicate the configured guard time respectively the life time factor. The life time factor multiplied with the guard time gives the life time for the life guarding protocol.

VALUE DEFINITION

The value shall be given in multiple of ms. The value of 0000_h shall disable the life guarding.

OBJECT DESCRIPTION

Index	100C _h
Name	Guard time
Object code	VAR
Data type	UNSIGNED16
Category	Conditional; Mandatory, if node guarding is supported

ENTRY DESCRIPTION

Sub-index	00 _h
Access	rw; ro, if life guarding is not supported
PDO mapping	No
Value range	UNSIGNED16
Default value	0000 _h

7.5.2.12 Object 100D_h: Life time factor

The life time factor multiplied with the guard time gives the life time for the life guarding protocol.

VALUE DEFINITION

The value of 00_h shall disable the life guarding.

OBJECT DESCRIPTION

Index	100D _h
Name	Life time factor
Object code	VAR
Data type	UNSIGNED8
Category	Conditional; Mandatory, if node guarding is supported

ENTRY DESCRIPTION

Sub-index	00 _h
Access	rw; ro, if life guarding is not supported
PDO mapping	No
Value range	UNSIGNED8
Default value	00 _h

7.5.2.13 Object 1010_h: Store parameters

This object shall control the saving of parameters in non-volatile memory.

VALUE DEFINITION

By read access the CANopen device shall provide information about its saving capabilities. Several parameter groups are distinguished:

- Sub-index 00_h contains the highest sub-index that is supported.
- Sub-index 01_h refers to all parameters that may be stored on the CANopen device.
- Sub-index 02_h refers to communication related parameters (index from 1000_h to 1FFF_h).
- Sub-index 03_h refers to application related parameters (index from 6000_h to 9FFF_h).
- Sub-index from 04_h to 7F_h manufacturers may store their choice of parameters individually.
- Sub-index from 80_h to FE_h are reserved for future use.

In order to avoid storage of parameters by mistake, storage shall be only executed when a specific signature is written to the appropriate sub-index. The signature that shall be written is "save":

Signature	MSB			LSB
/ISO8859/ character	e	v	a	s
hex	65 _h	76 _h	61 _h	73 _h

Figure 55: Storage write access signature

On reception of the correct signature in the appropriate sub-index the CANopen device shall store the parameter and then it shall confirm the SDO transmission (SDO download initiate response). If the storing failed, the CANopen device shall respond with the SDO abort transfer service (abort code: 0606 0000_h).

If a wrong signature is written, the CANopen device shall refuse to store and it shall respond with the SDO abort transfer service (abort code: 0800 002x_h).

On read access to the appropriate sub-index the CANopen device shall provide information about its storage functionality with the following format:

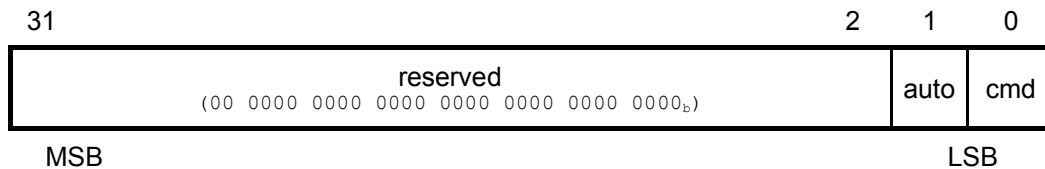

Figure 56: Storage read access structure

Table 56: Structure of read access

Bit	Value	Description
auto	0 _b	CANopen device does not save parameters autonomously
	1 _b	CANopen device saves parameters autonomously
cmd	0 _b	CANopen device does not save parameters on command
	1 _b	CANopen device saves parameters on command

Autonomous saving means that a CANopen device stores the storable parameters in a non-volatile manner without user request.

OBJECT DESCRIPTION

Index	1010 _h
Name	store parameters
Object code	ARRAY
Data type	UNSIGNED32
Category	Optional

ENTRY DESCRIPTION

Sub-index	00 _h
Description	highest sub-index supported
Entry category	Mandatory
Access	const
PDO mapping	No
Value range	01 _h to 7F _h
Default value	profile- or manufacturer-specific

Sub-index	01 _h
Description	save all parameters
Entry category	Mandatory
Access	rw ro, if autonomous storing is supported
PDO mapping	No
Value range	see <i>value definition</i> (Figure 55 for write access; Figure 56 for read access)
Default value	profile- or manufacturer specific

Sub-index	02 _h
Description	save communication parameters
Entry category	Optional
Access	rw ro, if autonomous storing is supported
PDO mapping	No
Value range	see <i>value definition</i> (Figure 55 for write access; Figure 56 for read access)
Default value	profile- or manufacturer-specific

Sub-index	03 _h
Description	save application parameters
Entry category	Optional
Access	rw ro, if autonomous storing is supported
PDO mapping	No
Value range	see <i>value definition</i> (Figure 55 for write access; Figure 56 for read access)
Default value	profile- or manufacturer-specific

Sub-index	04 _h to 7F _h
Description	save manufacturer defined parameters
Entry category	Optional
Access	rw ro, if autonomous storing is supported
PDO mapping	No
Value range	see <i>value definition</i> (Figure 55 for write access; Figure 56 for read access)
Default value	profile- or manufacturer-specific

7.5.2.14 Object 1011_h: Restore default parameters

With this object the default values of parameters according to the communication profile, device profile, and application profile are restored.

VALUE DEFINITION

By read access the CANopen device shall provide information about its capabilities to restore these values. Several parameter groups are distinguished:

- Sub-index 00_h contains the highest sub-index that is supported.
- Sub-index 01_h refers to all parameters that may be restored.
- Sub-index 02_h refers to communication related parameters (Index from 1000_h to 1FFF_h).
- Sub-index 03_h refers to application related parameters (Index from 6000_h to 9FFF_h).
- Sub-index from 04_h to 7F_h manufacturers may restore their individual choice of parameters.
- Sub-index from 80_h to FE_h are reserved for future use.

In order to avoid the restoring of default parameters by mistake, restoring shall be only executed when a specific signature is written to the appropriate sub-index. The signature that shall be written is "load":

Signature	MSB			LSB
/ISO8859/ character	d	a	o	l
hex	64 _h	61 _h	6F _h	6C _h

Figure 57: Restore default write access signature

On reception of the correct signature in the appropriate sub-index the CANopen device shall restore the default parameters and then it shall confirm the SDO transmission (SDO download

initiate response). If the restoring failed, the CANopen device shall respond with the SDO abort transfer service (abort code: 0606 0000_h). If a wrong signature is written, the CANopen device shall refuse to restore the defaults and shall respond with the SDO abort transfer service (abort code: 0800 002x_h).

The default values shall be set valid after the CANopen device is reset (NMT service reset node for sub-index from 01_h to 7F_h, NMT service reset communication for sub-index 02_h) or power cycled.

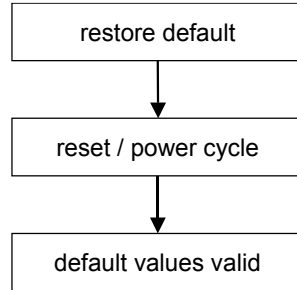

Figure 58: Restore procedure

On read access to the appropriate sub-index the CANopen device shall provide information about its default parameter restoring capability with the following format:



Figure 59: Restore default read access structure

Table 57: Structure of restore read access

Bit	Value	Description
cmd	0 _b	CANopen device does not restore default parameters
	1 _b	CANopen device restores parameters

OBJECT DESCRIPTION

Index	1011 _h
Name	restore default parameters
Object code	ARRAY
Data type	UNSIGNED32
Category	Optional

ENTRY DESCRIPTION

Sub-index	00 _h
Description	highest sub-index supported
Entry category	Mandatory
Access	const
PDO mapping	No
Value range	01 _h to 7F _h
Default value	profile- or manufacturer-specific

Sub-index	01 _h
Description	restore all default parameters
Entry category	Mandatory
Access	rw
PDO mapping	No
Value range	see <i>value definition</i> (Figure 57 for write access; Figure 59 for read access)
Default value	profile- or manufacturer-specific

Sub-index	02 _h
Description	restore communication default parameters
Entry category	Optional
Access	rw
PDO mapping	No
Value range	see <i>value definition</i> (Figure 57 for write access; Figure 59 for read access)
Default value	profile- or manufacturer-specific

Sub-index	03 _h
Description	restore application default parameters
Entry category	Optional
Access	rw
PDO mapping	No
Value range	see <i>value definition</i> (Figure 57 for write access; Figure 59 for read access)
Default value	profile- or manufacturer-specific

Sub-index	04 _h to 7F _h
Description	restore manufacturer defined default parameters
Entry category	Optional
PDO mapping	No
Value range	see <i>value definition</i> (Figure 57 for write access; Figure 59 for read access)
Default value	profile- or manufacturer-specific

7.5.2.15 Object 1012h: COB-ID time stamp object

This object shall indicate the configured COB-ID of the Time-Stamp Object (TIME). Further, it defines whether the CANopen device consumes the TIME or whether the CANopen device generates the TIME. The structure of this object is specified in Figure 60 and Table 58.

VALUE DEFINITION

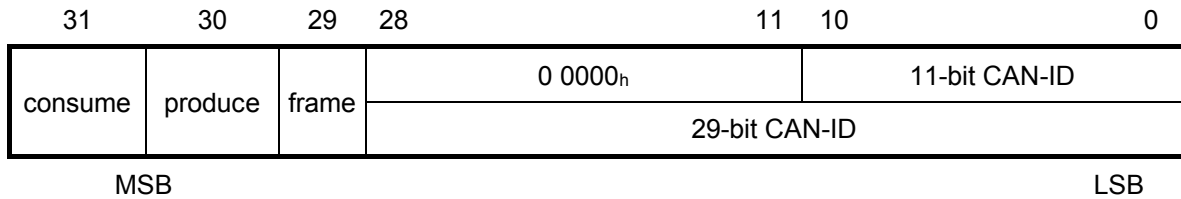

Figure 60: Structure of TIME COB-ID

Table 58: Description of TIME COB-ID

Bit(s)	Value	Description
consume	0 _b	CANopen device does not consume TIME message
	1 _b	CANopen device consumes TIME message
produce	0 _b	CANopen device does not produce TIME message
	1 _b	CANopen device produces TIME message
frame	0 _b	11-bit CAN-ID valid (CAN base frame)
	1 _b	29-bit CAN-ID valid (CAN extended frame)
29-bit CAN-ID	x	29-bit CAN-ID of the CAN extended frame
11-bit CAN-ID	x	11-bit CAN-ID of the CAN base frame

Bits 29 (frame), 30 (produce) may be static (not changeable). If a CANopen device is not able to generate TIME messages, an attempt to set bit 30 (produce) to 1_b shall be responded with the SDO abort transfer service (abort code: 0609 0030_h). CANopen devices supporting the CAN base frame type only, an attempt to set bit 29 (frame) to 1_b shall be responded with the SDO abort transfer service (abort code: 0609 0030_h). The bits 0 to 29 shall not be changed, while the object exists (bit 30 = 1_b or bit 31 = 1_b).

OBJECT DESCRIPTION

Index	1012 _h
Name	COB-ID time stamp message
Object code	VAR
Data type	UNSIGNED32
Category	Optional

ENTRY DESCRIPTION

Sub-index	00 _h
Access	rw
PDO mapping	No
Value range	UNSIGNED32
Default value	CAN-ID: 100 _h frame: 0 _b valid: profile- or manufacturer-specific

7.5.2.16 Object 1013_h: High resolution time stamp

This object shall indicate the configured high resolution time stamp. It may be mapped into a PDO in order to exchange a high resolution time stamp message. Further application specific use is encouraged.

VALUE DEFINITION

The value is given in multiples of 1 μs.

OBJECT DESCRIPTION

Index	1013 _h
Name	high resolution time stamp
Object code	VAR
Data type	UNSIGNED32
Category	Optional

ENTRY DESCRIPTION

Sub-index	00 _h
Access	rw; ro, if only high resolution time stamp producer is supported rw or wo, if only high resolution time stamp consumer is supported
PDO mapping	Optional
Value range	UNSIGNED32
Default value	0

7.5.2.17 Object 1014_h: COB-ID EMCY

This object shall indicate the configured COB-ID for the EMCY write service.

VALUE DEFINITION

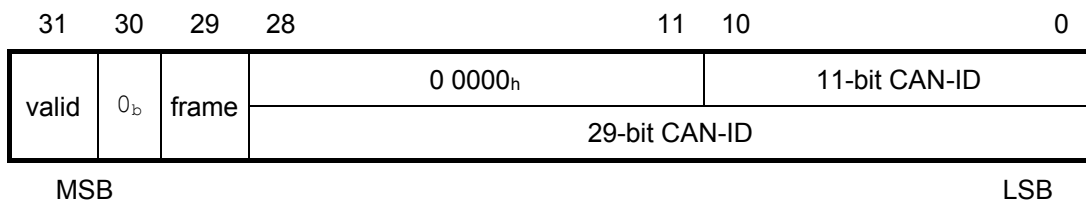

Figure 61: Structure of the EMCY Identifier

Table 59: Description of EMCY COB-ID

Bit(s)	Value	Description
valid	0 _b	EMCY exists / is valid
	1 _b	EMCY does not exist / is not valid
30	0 _b	reserved (always 0 _b)
frame	0 _b	11-bit CAN-ID valid (CAN base frame)
	1 _b	29-bit CAN-ID valid (CAN extended frame)
29-bit CAN-ID	x	29-bit CAN-ID of the CAN extended frame
11-bit CAN-ID	x	11-bit CAN-ID of the CAN base frame

CANopen devices supporting the CAN base frame type only shall respond with the SDO abort transfer service (abort code: 0609 0030_h) in the case of an attempt to set bit 29 (frame) to 1_b. The bits 0 to 29 shall not be changed, while the object exists and is valid (bit 31 = 0_b).

OBJECT DESCRIPTION

Index	1014 _h
Name	COB-ID emergency message
Object code	VAR
Data type	UNSIGNED32
Category	Conditional; Mandatory, if Emergency is supported

ENTRY DESCRIPTION

Sub-index	00 _h
Access	rw; const, if COB-ID is not changeable
PDO mapping	No
Value range	UNSIGNED32
Default value	CAN-ID: 80 _h + Node-ID frame: 0 _b valid: profile- or manufacturer-specific

7.5.2.18 Object 1015_h: Inhibit time EMCY

This object shall indicate the configured inhibit time for the EMCY message.

VALUE DEFINITION

The value shall be given in multiples of 100 μs. The value 0 shall disable the inhibit time.

OBJECT DESCRIPTION

Index	1015 _h
Name	inhibit time EMCY
Object code	VAR
Data type	UNSIGNED16
Category	Optional

ENTRY DESCRIPTION

Sub-index	00 _h
Access	rw
PDO mapping	No
Value range	UNSIGNED16
Default value	0

7.5.2.19 Object 1016_h: Consumer heartbeat time

The consumer heartbeat time object shall indicate the expected heartbeat cycle times. Monitoring of the heartbeat producer shall start after the reception of the first heartbeat.

NOTE: The consumer heartbeat time should be higher than the corresponding producer heartbeat time.

NOTE: Before the reception of the first heartbeat the status of the heartbeat producer is unknown.

VALUE DEFINITION

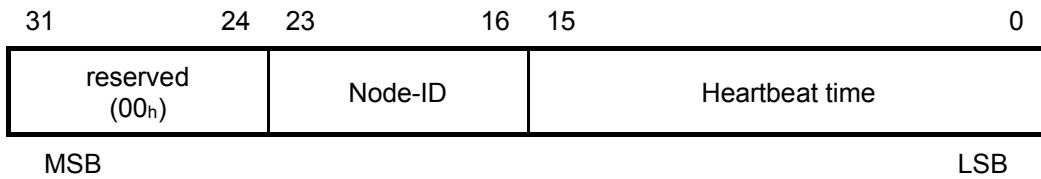

Figure 62: Structure of Consumer heartbeat time

If the heartbeat time is 0 or the node-ID is 0 or greater than 127 the corresponding object entry shall be not used. The heartbeat time shall be given in multiples of 1ms.

An attempt to configure several heartbeat times unequal 0 for the same node-ID the CANopen device shall be responded with the SDO abort transfer service (abort code: 0604 0043_h).

OBJECT DESCRIPTION

Index	1016 _h
Name	Consumer heartbeat time
Object code	ARRAY
Data type	UNSIGNED32
Category	Optional

ENTRY DESCRIPTION

Sub-index	00 _h
Description	Highest sub-index supported
Entry category	Mandatory
Access	const
PDO mapping	No
Value range	01 _h to 7F _h
Default value	profile- or manufacturer-specific

Sub-index	01 _h
Description	Consumer heartbeat time
Entry category	Mandatory
Access	rw
PDO mapping	No
Value range	UNSIGNED32 (Figure 62)
Default value	0000 0000 _h

Sub-index	02 _h to 7F _h
Description	Consumer heartbeat time
Entry category	Optional
Access	rw
PDO mapping	No
Value range	UNSIGNED32 (Figure 62)
Default value	0000 0000 _h

7.5.2.20 Object 1017_h: Producer heartbeat time

The producer heartbeat time shall indicate the configured cycle time of the heartbeat.

VALUE DEFINITION

The value shall be given in multiples of 1 ms. The value 0 shall disable the producer heartbeat.

OBJECT DESCRIPTION

Index	1017 _h
Name	Producer heartbeat time
Object code	VAR
Data type	UNSIGNED16
Category	Conditional; Mandatory, if guarding not supported

ENTRY DESCRIPTION

Sub-index	00 _h
Access	rw const, if default value is profile-specific and not changeable
PDO mapping	No
Value range	UNSIGNED16
Default value	0 or profile-specific

7.5.2.21 Object 1018_h: Identity object

This object shall provide general identification information of the CANopen device.

VALUE DEFINITION

Sub-index 01_h shall contain the unique value¹ that is allocated uniquely to each vendor of a CANopen device. The value 0000 0000_h shall indicate an invalid vendor-ID.

Sub-index 02_h shall contain the unique value that identifies a specific type of CANopen devices. The value of 0000 0000_h shall be reserved.

Sub-index 03_h shall contain the major revision number and the minor revision number of the revision of the CANopen device (see Figure 63). The major revision number shall identify a specific CANopen behavior. That means if the CANopen functionality is different, the major revision number shall be incremented. The minor revision number shall identify different versions of CANopen device with the same CANopen behavior. The value of 0000 0000_h shall be reserved.

¹ The value is assigned uniquely by CAN in Automation (CiA).

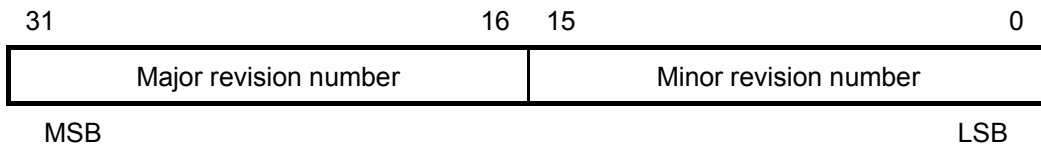

Figure 63: Structure of revision number

Sub-index 04_h shall contain the serial number that identifies uniquely a CANopen device within a product group and a specific revision. The value of 0000 0000_h shall be reserved.

OBJECT DESCRIPTION

Index	1018 _h
Name	Identity object
Object code	RECORD
Data type	Identity
Category	Mandatory

ENTRY DESCRIPTION

Sub-index	00 _h
Description	Highest sub-index supported
Entry category	Mandatory
Access	const
PDO mapping	No
Value range	01 _h to 04 _h
Default value	profile- or manufacturer-specific

Sub-index	01 _h
Description	Vendor-ID
Entry category	Mandatory
Access	ro
PDO mapping	No
Value range	UNSIGNED32
Default value	Assigned uniquely to manufacturers by CiA

Sub-index	02 _h
Description	Product code
Entry category	Optional
Access	ro
PDO mapping	No
Value range	UNSIGNED32
Default value	Profile- or manufacturer-specific

Sub-index	03 _h
Description	Revision number
Entry category	Optional
Access	ro
PDO mapping	No
Value range	UNSIGNED32
Default value	Profile- or manufacturer-specific

Sub-index	04 _h
Description	Serial number
Entry category	Optional
Access	ro
PDO mapping	No
Value range	UNSIGNED32
Default value	Profile- or manufacturer-specific

7.5.2.22 Object 1019_h: Synchronous counter overflow value

This object shall indicate the configured highest value the synchronous counter supports. This object shall be implemented by the producer and the consumer, if the synchronous counter is supported by the CANopen device. If the value is greater than 1, the SYNC message shall have a data length of 1 byte. The SYNC consumer shall ignore the value itself. An EMCY message (error code: 8240_h – unexpected SYNC data length) may be transmitted by a SYNC consumer in the case the configured data length of the SYNC message does not meet the data length of a received SYNC message.

VALUE DEFINITION

Value	Description
0	The SYNC message shall be transmitted as a CAN message of data length 0.
1	reserved
2 to 240	The SYNC message shall be transmitted as a CAN message of data length 1. The first data byte contains the counter.
241 to 255	reserved

The value used shall be the least common multiple of all the TPDO transmission types ($1 < n \leq 240$) used. This ensures that periodic SYNC events always happen in the SYNC cycles with the same counter value.

A change of the value shall be responded with a SDO abort (abort code: 0800 0022_h or 0800 0000_h) in case the sync cycle period is unequal to 0.

OBJECT DESCRIPTION

Index	1019 _h
Name	Synchronous counter overflow value
Object code	VAR
Data type	UNSIGNED8
Category	Optional

ENTRY DESCRIPTION

Sub-index	00 _h
Access	rw; const, if default value is profile-specific and not changeable
PDO mapping	No
Value range	UNSIGNED8
Default value	0 or profile-specific

7.5.2.23 Object 1020_h: Verify configuration

This object shall indicate the downloaded configuration date and time. If a CANopen device supports the saving of parameters in non-volatile memory, a network configuration tool or a CANopen manager uses this object to verify the configuration after a CANopen device reset and to check if a reconfiguration is necessary. The configuration tool stores the date and time in that object and stores the same values in the DCF. Now the configuration tool lets the CANopen device save its configuration by writing to index 1010_h sub-index 01_h the signature "save". After a reset the CANopen device shall restore the last configuration and the signature automatically or by request. If any other command changes boot-up configuration values, the CANopen device shall reset the object Verify Configuration to 0.

The Configuration Manager compares signature and configuration with the value from the DCF and decides if a reconfiguration is necessary or not.

Note: The usage of this object allows a significant speed-up of the boot-up process. If it is used, the system integrator considers that an user changes a configuration value and afterwards activate the command store configuration 1010_h without changing the value of 1020_h. So the system integrator ensures a 100% consequent usage of this feature.

VALUE DEFINITION

Sub-index 01_h (configuration date) shall contain the number of days since January 1, 1984.

Sub-index 02_h (configuration time) shall be the number of ms after midnight.

OBJECT DESCRIPTION

Index	1020 _h
Name	Verify configuration
Object code	ARRAY
Data type	UNSIGNED32
Category	Optional

ENTRY DESCRIPTION

Sub-index	00 _h
Description	Highest sub-index supported
Entry category	Mandatory
Access	const
PDO mapping	No
Value range	02 _h
Default value	02 _h

Sub-index	01 _h
Description	Configuration date
Entry category	Mandatory
Access	rw
PDO mapping	No
Value range	UNSIGNED32
Default value	Manufacturer-specific

Sub-index	02 _h
Description	Configuration time
Entry category	Mandatory
Access	rw
PDO mapping	No
Value range	UNSIGNED32
Default value	Manufacturer-specific

7.5.2.24 Object 1021_h: Store EDS

This object shall indicate the downloaded EDS. The storage of EDS files in the CANopen device has some advantages:

- The manufacturer has not the problem of distributing the EDS via disks
- Management of different EDS versions for different software versions is less error prone, if they are stored together
- The complete network settings is stored in the network. This makes the task of analyzing or reconfiguring a network easier for tools and more transparent for the users.

VALUE DEFINITION

The filename does not need to be stored since every EDS contains its own filename.

OBJECT DESCRIPTION

Index	1021 _h
Name	Store EDS
Object code	VAR
Data type	DOMAIN
Category	Optional

ENTRY DESCRIPTION

Sub-index	00 _h
Access	ro
PDO mapping	No
Value range	Manufacturer-specific
Default value	No

7.5.2.25 Object 1022_h: Store format

The object shall indicate the format of the storage. This allows the usage of compressed formats. The object describes the external behavior only.

VALUE DEFINITION

Table 60: Values for EDS store formats

Value	Description
00 _h	/ISO10646/, not compressed
01 _h	reserved
.....
7F _h	reserved
80 _h	manufacturer-specific
.....
FF _h	manufacturer-specific

OBJECT DESCRIPTION

Index	1022 _h
Name	Store format
Object code	VAR
Data type	UNSIGNED16
Category	Conditional; Mandatory if store EDS is supported

ENTRY DESCRIPTION

Sub-index	00 _h
Access	ro
PDO mapping	No
Value range	UNSIGNED8
Default value	No

7.5.2.26 Object 1023_h: OS command

The OS Command object shall be used as a command driven interface to programmable devices. The contents of the command are /ISO8859/ characters or binary and are completely manufacturer-specific. The host system puts the command into the object OS command.

VALUE DEFINITION

If a CANopen device implements this function, all sub-indices are mandatory, additional object entries are manufacturer-specific. A new command may be entered, if status is in the range from 0 to 3: The command and all parameters shall be transmitted in one block to sub-index 01_h. The execution of the command shall start immediately after the completion of the transfer. The host polls sub-index 02_h, until it is a value from 0 to 3. It may then transfer the reply, if status is a value of 1 or 3. The CANopen device shall return the same reply, if reply is requested more then one time, or may change status from 1 to 0 or 3 to 2, if it is not able to buffer the reply.

OBJECT DESCRIPTION

Index	1023 _h
Name	OS command
Object code	RECORD
Data type	OS command record
Category	Optional

ENTRY DESCRIPTION

Sub-index	00 _h
Description	Highest sub-index supported
Entry category	Mandatory
Access	const
PDO mapping	No
Value range	03 _h
Default value	03 _h

Sub-index	01 _h
Description	Command
Entry category	Mandatory
Access	rw; wo, if only writing is supported
PDO mapping	No
Value range	No
Default value	Manufacturer-specific

Sub-index	02 _h
Description	Status
Entry category	Mandatory
Access	ro
PDO mapping	No
Value range	UNSIGNED8
Default value	No

Sub-index	03 _h
Description	Reply
Entry category	Mandatory
Access	ro
PDO mapping	No
Value range	No
Default value	No

7.5.2.27 Object 1024_h: OS command mode

This object shall control the command execution in the application specific queue. It is intended that this object represent the most recent command of an application program specific queue.

VALUE DEFINITION

Table 61: OS command mode values

Value	Description
00 _h	Execute the next command immediately
01 _h	Buffer the next command
02 _h	Execute the commands in the buffer
03 _h	Abort the current command and all commands in the buffer
04 _h	Manufacturer-specific
.....
FF _h	Manufacturer-specific

OBJECT DESCRIPTION

Index	1024 _h
Name	OS command mode
Object code	VAR
Data type	UNSIGNED8
Category	Optional

ENTRY DESCRIPTION

Sub-index	00 _h
Access	wo
PDO mapping	No
Value range	UNSIGNED8
Default value	Manufacturer-specific

7.5.2.28 Object 1025_h: OS debugger interface

This object shall provide the OS debugger interface. It is the binary command interface to the debugger agents of the programmable CANopen device. The contents of the commands are manufacturer-specific. This object enables the user to connect with a remote debugger.

VALUE DEFINITION

see OS command

OBJECT DESCRIPTION

Index	1025 _h
Name	OS debugger interface
Object code	RECORD
Data type	OS debug record
Category	Optional

ENTRY DESCRIPTION

Sub-index	00 _h
Description	Highest sub-index supported
Entry category	Mandatory
Access	const
PDO mapping	No
Value range	03 _h
Default value	03 _h

Sub-index	01 _h
Description	Command
Entry category	Mandatory
Access	rw; wo, if only writing is supported
PDO mapping	No
Value range	No
Default value	Manufacturer-specific

Sub-index	02 _h
Description	Status
Entry category	Mandatory
Access	ro
PDO mapping	No
Value range	UNSIGNED8
Default value	No

Sub-index	03 _h
Description	Reply
Entry category	Mandatory
Access	ro
PDO mapping	No
Value range	No
Default value	No

7.5.2.29 Object 1026_h: OS prompt

The OS prompt object is a character driven command interface to programmable CANopen devices. The contents of the commands are manufacturer-specific. This object enables the user to have remote keyboard control.

VALUE DEFINITION

Sub-index 01_h StdIn is used to transmit single characters to the CANopen device by SDO or PDO. Each new character shall be appended to the internal input queue. Answers of the CANopen device shall be output on sub-index 02_h StdOut. This object is mappable to an event-driven PDO or polled by SDO. Sub-index 03_h StdErr is used for error output. This object is mappable to an event-driven PDO or polled by SDO.

OBJECT DESCRIPTION

Index	1026 _h
Name	OS prompt
Object code	ARRAY
Data type	UNSIGNED8
Category	Optional

ENTRY DESCRIPTION

Sub-index	00 _h
Description	Highest sub-index supported
Entry category	Mandatory
Access	const
PDO mapping	No
Value range	02 _h to 03 _h
Default value	No

Sub-index	01 _h
Description	StdIn
Entry category	Mandatory
Access	wo
PDO mapping	Optional
Value range	UNSIGNED8
Default value	Manufacturer-specific

Sub-index	02 _h
Description	StdOut
Entry category	Mandatory
Access	ro
PDO mapping	Optional
Value range	UNSIGNED8
Default value	No

Sub-index	03 _h
Description	StdErr
Entry category	Optional
Access	ro
PDO mapping	Optional
Value range	UNSIGNED8
Default value	No

7.5.2.30 Object 1027_h: Module list

A common method to provide modular CANopen devices is the usage of a bus coupler that allows connecting several combinations of modules. The object shall provide information on the currently attached modules.

VALUE DEFINITION

The consecutive sub-indexes ($1 \leq N \leq 254$) describe the corresponding modules in the order they are attached. Each object entry shall contain a number that identifies the module. For this the number shall be unique within all module types that are attached to this bus coupler device type.

The object entry at sub-index 00_h shall contain the actual number of modules that are connected to the bus coupler.

NOTE: If no module is present the value of sub-index 00_h is 00_h and a read access to sub-index 01_h is responded with an SDO abort message (abort code: $0800\ 0024_h$ or $0800\ 0000_h$).

OBJECT DESCRIPTION

Index	1027_h
Name	Module list
Object code	ARRAY
Data type	UNSIGNED16
Category	Conditional; Mandatory, if modular devices supported

ENTRY DESCRIPTION

Sub-index	00_h
Description	number of connected modules
Entry category	Mandatory
Access	const
PDO mapping	No
Value range	01_h to FE_h
Default value	No

Sub-index	01_h
Description	Module 1
Entry category	Mandatory
Access	ro
PDO mapping	No
Value range	UNSIGNED16
Default value	No

Sub-index	02 _h to FE _h
Description	Module 2 to Module 254
Entry category	Optional
Access	ro
PDO mapping	No
Value range	UNSIGNED16
Default value	No

7.5.2.31 Object 1028_h: Emergency consumer object

This objects shall indicate the configured COB-IDs for the EMCY objects that the CANopen device is consuming.

VALUE DEFINITION

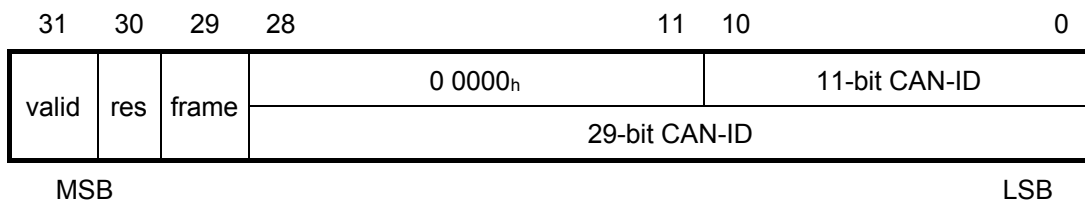

Figure 64: Structure of EMCY COB-ID

Table 62: Description of EMCY COB-ID

Bit(s)	Value	Description
valid	0 _b	EMCY consumer exists / is valid
	1 _b	EMCY consumer does not exist / is not valid
res	0 _b	reserved (always 0 _b)
frame	0 _b	11-bit CAN-ID valid (CAN base frame)
	1 _b	29-bit CAN-ID valid (CAN extended frame)
29-bit CAN-ID	x	29-bit CAN-ID of the CAN extended frame
11-bit CAN-ID	x	11-bit CAN-ID of the CAN base frame

CANopen devices supporting the CAN base frame type only, an attempt to set bit 29 (frame) to 1_b shall be responded with the SDO abort transfer service (abort code: 0609 0030_h). The bits 0 to 29 shall not be changed, while the object exists and is valid (bit 31 = 0_b).

The Sub-index shall refer to the related node-ID.

OBJECT DESCRIPTION

Index	1028 _h
Name	Emergency consumer
Object code	ARRAY
Data type	UNSIGNED32
Category	Optional

ENTRY DESCRIPTION

Sub-index	00 _h
Description	Highest sub-index supported
Entry category	Mandatory
Access	const
PDO mapping	No
Value range	01 _h to 7F _h
Default value	profile- or manufacturer-specific

Sub-index	01 _h
Description	Emergency consumer 1
Entry category	Mandatory
Access	rw; const, if emergency consumer value is not changeable
PDO mapping	No
Value range	<i>see value definition</i>
Default value	profile- or manufacturer-specific

Sub-index	02 _h to 7F _h
Description	Emergency consumer 2 to 127
Entry category	Optional
Access	rw; const, if emergency consumer value is not changeable
PDO mapping	No
Value range	<i>see value definition</i>
Default value	profile- or manufacturer-specific

7.5.2.32 Object 1029_h: Error behavior object

If a serious CANopen device failure is detected in NMT state Operational, the CANopen device shall enter by default autonomously the NMT state Pre-operational. If the object is implemented, the CANopen device is configurable to enter alternatively the NMT state Stopped or remain in the current NMT state. CANopen device failures shall include the following communication errors:

- Bus-off conditions of the CAN interface
- Life guarding event with the state 'occurred' and the reason 'time out'
- Heartbeat event with state 'occurred' and the reason 'time out'

Severe CANopen device errors also may be caused by CANopen device internal failures.

VALUE DEFINITION

Table 63: Error class values

Value	Description
00 _h	Change to NMT state Pre-operational (only if currently in NMT state Operational)
01 _h	No change of the NMT state
02 _h	Change to NMT state Stopped
03 _h	reserved
.....
7F _h	reserved
80 _h	Manufacturer-specific
.....
FF _h	Manufacturer-specific

OBJECT DESCRIPTION

Index	1029 _h
Name	Error behavior
Object code	ARRAY
Data type	UNSIGNED8
Category	Optional

ENTRY DESCRIPTION

Sub-index	00 _h
Description	Highest sub-index supported
Entry category	Mandatory
Access	const
PDO mapping	No
Value range	01 _h to FE _h
Default value	profile- or manufacturer-specific

Sub-index	01 _h
Description	Communication error
Entry category	Mandatory
Access	rw; const, if error behavior for communication errors is not changeable
PDO mapping	No
Value range	UNSIGNED8
Default value	00 _h

Sub-index	02 _h to FE _h
Description	profile- or manufacturer-specific error
Entry category	Optional
Access	rw; const, if error behavior is not changeable
PDO mapping	No
Value range	<i>see value definition</i>
Default value	profile or manufacturer-specific

7.5.2.33 Object 1200_h to 127F_h: SDO server parameter

In order to describe the SDOs used on a CANopen device the data type SDO Parameter is introduced. The data type has the index 22_h in the object dictionary. The structure is defined in clause 7.4.8.

VALUE DEFINITION

The number of supported object entries in the SDO object record is specified at sub-index 00_h. The values at sub-index 01_h and sub-index 02_h specify the COB-ID for this SDO. Sub-index 03_h is the node-ID of the SDO client associated to this CANopen device.

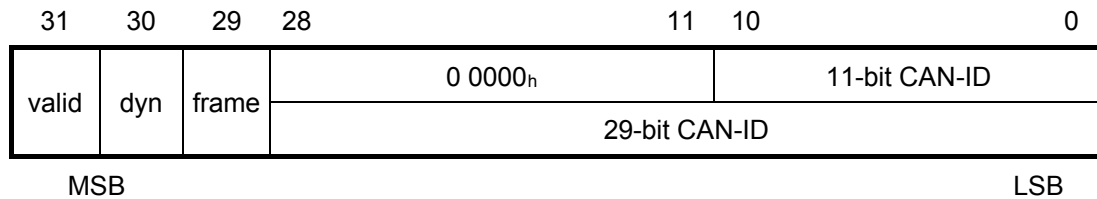

Figure 65: Structure of SDO server COB-ID

Table 64: Description of SDO server COB-ID

Bit(s)	Value	Description
valid	0 _b	SDO exists / is valid
	1 _b	SDO does not exist / is not valid
dyn	0 _b	Value is assigned statically
	1 _b	Value is assigned dynamically
frame	0 _b	11-bit CAN-ID valid (CAN base frame)
	1 _b	29-bit CAN-ID valid (CAN extended frame)
29-bit CAN-ID	x	29-bit CAN-ID of the CAN extended frame
11-bit CAN-ID	x	11-bit CAN-ID of the CAN base frame

An SDO exists only if at both sub-index 01_h and sub-index 02_h the bit valid (bit 31) is set to 0_b. CANopen devices supporting the CAN base frame type only, an attempt to set bit 29 (frame) to 1_b is responded with the SDO abort transfer service (abort code: 0609 0030_h). It is not allowed to change bits 0 to 29 while the object exists and is valid (bit 31 = 0_b).

If the bit *dyn* (bit 30) of sub-index 01_h or sub-index 02_h is set to 1_b the values of all sub-indices of this object shall not be stored in non-volatile memory. The bit *dyn* may be used to mark dynamic SDO connections between CANopen devices. Dynamic SDO connections are temporarily configured. Static SDO connections are configured non-temporarily and may be saved in non-

volatile memory. The CANopen manager may use the *dyn* bit to detect temporarily configured SDO connections.

OBJECT DESCRIPTION

Index	1200 _h to 127F _h
Name	SDO server parameter
Object code	RECORD
Data type	SDO parameter record
Category	Conditional Index 1200 _h : Optional Index 1201 _h to 127F _h : Mandatory for each additionally supported SDO server

ENTRY DESCRIPTION

Sub-index	00 _h
Description	Highest sub-index supported
Entry category	Mandatory
Access	const
PDO mapping	No
Value range	Index 1200 _h : 02 _h Index 1201 _h to 127F _h : 02 _h to 03 _h
Default value	profile or manufacturer-specific

Sub-index	01 _h
Description	COB-ID client -> server (rx)
Entry category	Mandatory
Access	Index 1200 _h : const Index 1201 _h to 127F _h : rw; const, if defined by application profile
PDO mapping	Optional
Value range	<i>see value definition</i>
Default value	Index 1200 _h : CAN-ID: 600 _h + Node-ID frame: 0 _b dyn: 0 _b valid: 0 _b Index 1201 _h to 127F _h : CAN-ID: manufacturer-specific (see clause 7.3.5) frame: manufacturer-specific dyn: 0 _b valid: 1 _b or defined by application profile

Sub-index	02 _h
Description	COB-ID server -> client (tx)
Entry category	Mandatory
Access	Index 1200 _h : ro Index 1201 _h to 127F _h : rw; const, if defined by application profile
PDO mapping	Optional
Value range	see value definition
Default value	Index 1200 _h : CAN-ID: 580 _h + Node-ID frame: 0 _b dyn: 0 _b valid: 0 _b Index 1201 _h to 127F _h : CAN-ID: manufacturer-specific (see clause 7.3.5) frame: manufacturer-specific dyn: 0 _b valid: 1 _b or defined by application profile

Sub-index	03 _h
Description	Node-ID of the SDO client
Entry category	Optional
Access	rw
PDO mapping	No
Value range	01 _h to 7F _h
Default value	manufacturer-specific

7.5.2.34 Object 1280_h to 12FF_h: SDO client parameter

These objects contain the parameters for the SDOs for which the CANopen device is the SDO client. If the object is supported, all sub-indices shall be available. Starting at index 1280_h and subsequent indices.

VALUE DEFINITION

The number of supported object entries in the SDO object record is specified at sub-index 00_h. The values at sub-index 01_h and sub-index 02_h specify the COB-ID for this SDO. Sub-index 03_h is the node-ID of the SDO server associated to this CANopen device.

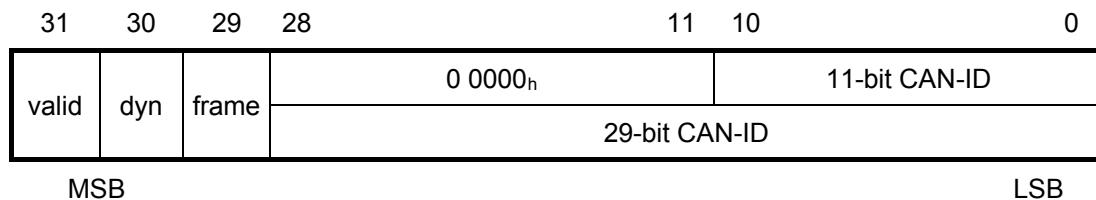

Figure 66: Structure of SDO client COB-ID

Table 65: Description of SDO client COB-ID

Bit(s)	Value	Description
valid	0 _b	SDO exists / is valid
	1 _b	SDO does not exist / is not valid
dyn	0 _b	Value is assigned statically
	1 _b	Value is assigned dynamically
frame	0 _b	11-bit CAN-ID valid (CAN base frame)
	1 _b	29-bit CAN-ID valid (CAN extended frame)
29-bit CAN-ID	x	29-bit CAN-ID of the CAN extended frame
11-bit CAN-ID	x	11-bit CAN-ID of the CAN base frame

An SDO exists only if at both sub-index 01_h and sub-index 02_h the bit valid (bit 31) is set to 0_b. CANopen devices supporting the CAN base frame type only, an attempt to set bit 29 (frame) to 1_b is responded with the SDO abort transfer service (abort code: 0609 0030_h). It is not allowed to change bits 0 to 29 while the object exists and is valid (bit 31 = 0_b). CANopen devices supporting the enabling (bit 31 = 0_b) and disabling (bit 31 = 1_b) of the SDO client only shall respond with the SDO abort transfer service (abort code: 0609 0030_h or 0800 000_h) on an attempt to change the values from bit 0 to bit 30.

If the bit *dyn* (bit 30) of sub-index 01_h or sub-index 02_h is set to 1_b the values of all sub-indices of this object shall not be stored in non-volatile memory. The bit *dyn* may be used to mark dynamic SDO connections between CANopen devices. Dynamic SDO connections are temporarily configured. Static SDO connections are configured non-temporarily and may be saved in non-volatile memory. The CANopen manager may use the *dyn* bit to detect temporarily configured SDO connections.

OBJECT DESCRIPTION

Index	1280 _h to 12FF _h
Name	SDO client parameter
Object code	RECORD
Data type	SDO Parameter
Category	Conditional; Mandatory for each supported SDO client

ENTRY DESCRIPTION

Sub-index	00 _h
Description	Highest sub-index supported
Entry category	Mandatory
Access	const
PDO mapping	No
Value range	03 _h
Default value	03 _h

Sub-index	01 _h
Description	COB-ID client -> server (tx)
Entry category	Mandatory
Access	rw; const, if defined by application profile
PDO mapping	Optional
Value range	<i>see value definition</i>
Default value	CAN-ID: manufacturer-specific (see clause 7.3.5) frame: manufacturer-specific dyn: 0 _b valid: 1 _b or defined by application profile

Sub-index	02 _h
Description	COB-ID server -> client (rx)
Entry category	Mandatory
Access	rw; const, if defined by application profile
PDO mapping	Optional
Value range	<i>see value definition</i>
Default value	CAN-ID: manufacturer-specific (see clause 7.3.5) frame: manufacturer-specific dyn: 0 _b valid: 1 _b or defined by application profile

Sub-index	03 _h
Description	Node-ID of the SDO server
Entry category	Mandatory
Access	rw; const, if value is not changeable
PDO mapping	No
Value range	01 _h to 7F _h
Default value	manufacturer-specific

7.5.2.35 Object 1400_h to 15FF_h: RPDO communication parameter

This object contains the communication parameters for the PDOs the CANopen device is able to receive.

VALUE DEFINITION

Sub-index 00_h contains the number of valid object entries within the record. Its value is at least 02_h. If inhibit time supported the value is 03_h and if event timer is supported the value is 05_h.

Sub-index 01_h contains the COB-ID of the RPDO (see Figure 67 and Table 66).

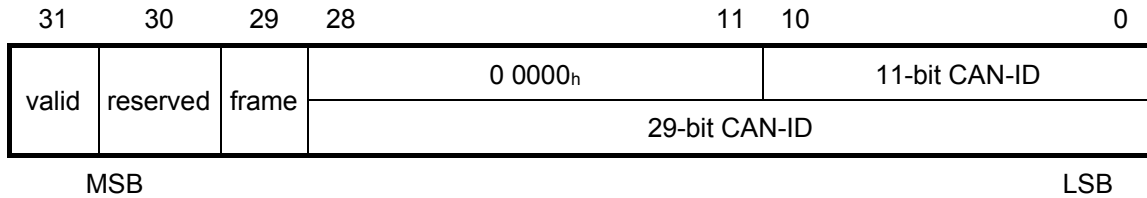

Figure 67: Structure of RPDO COB-ID

Table 66: Description of RPDO COB-ID

Bit(s)	Value	Description
valid	0 _b	PDO exists / is valid
	1 _b	PDO does not exist / is not valid
reserved	x	do not care
frame	0 _b	11-bit CAN-ID valid (CAN base frame)
	1 _b	29-bit CAN-ID valid (CAN extended frame)
29-bit CAN-ID	x	29-bit CAN-ID of the CAN extended frame
11-bit CAN-ID	x	11-bit CAN-ID of the CAN base frame

The bit valid (bit 31) allows selecting which RPDOs are used in the NMT state Operational. There may be PDOs fully configured (e.g. by default) but not used, and therefore set to "not valid" (deleted). The feature is necessary for CANopen devices supporting more than 4 RPDOs, because each CANopen device has only default CAN-IDs for the first four RPDOs in the generic pre-defined connection set. CANopen devices supporting the CAN base frame type only an attempt to set bit 29 (frame) to 1_b is responded with the SDO abort transfer service (abort code: 0609 0030_h). It is not allowed to change bit 0 to 29 while the PDO exists and is valid (bit 31 = 0_b). CANopen devices supporting the enabling (bit 31 = 0_b) and disabling (bit 31 = 1_b) of an RPDO only shall respond with the SDO abort transfer service (abort code: 0609 0030_h or 0800 000_h) on an attempt to change the values from bit 0 to bit 30.

If the CANopen device has implemented one or more device profiles the generic pre-defined connection set shall apply (see Table 67).

Table 67: Generic pre-defined connection set for RPDO

Index	Default value
1400 _h	CAN-ID: 200 _h + Node-ID frame: 0 _b reserved: manufacturer-specific valid: profile or manufacturer-specific
1401 _h	CAN-ID: 300 _h + Node-ID 29-bit: 0 _b reserved: manufacturer-specific valid: profile or manufacturer-specific
1402 _h	CAN-ID: 400 _h + Node-ID frame: 0 _b reserved: manufacturer-specific valid: profile- or manufacturer-specific
1403 _h	CAN-ID: 500 _h + Node-ID frame: 0 _b reserved: manufacturer-specific valid: profile- or manufacturer-specific

Index	Default value
1404 _h to 15FF _h	CAN-ID: profile- or manufacturer-specific (see clause 7.3.5) frame: profile- or manufacturer-specific reserved: manufacturer-specific valid: 1 _b or defined by application profile

If the CANopen device has implemented an application profile the specific pre-defined connection set of that application profile shall apply.

Sub-index 02_h defines the reception character of the RPDO (see Table 68). An attempt to change the value of the transmission type to any not supported value shall be responded with the SDO abort transfer service (abort code: 0609 0030_h).

Table 68: Description of RPDO transmission type

Value	Description
00 _h	synchronous
.....
F0 _h	synchronous
F1 _h	reserved
.....
FD _h	reserved
FE _h	event-driven (manufacturer-specific)
FF _h	event-driven (device profile and application profile specific)

- Synchronous means that the CANopen device shall actuate the received data with the reception of the next SYNC (see Figure 68).
- Event-driven means that the PDO may be received at any time. The CANopen device will actualize the data immediately.

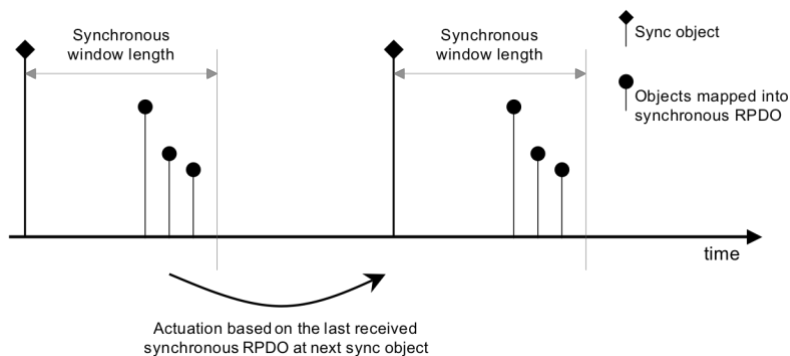

Figure 68: Bus synchronization and actuation

Sub-index 03_h contains the inhibit time. The value is defined as multiple of 100 μs. The value of 0 shall disable the inhibit time. It is not allowed to change the value while the PDO exists (bit 31 of sub-index 01_h is set to 0_b). The RPDO may use the time implementation specific.

Sub-index 04_h is reserved. It shall not be implemented; in this case read or write access leads to the SDO abort transfer service (abort code: 0609 0011_h).

Sub-index 05_h contains the event-timer. The value is defined as multiple of 1 ms. The value of 0 shall disable the event-timer. The RPDO may use the time for deadline monitoring. The deadline monitoring is activated within the next reception of an RPDO after configuring the event-timer. A timeout results in an indication to the local application.

Sub-index 06_h contains the SYNC start value. This is not used by RPDOs. It shall not be implemented; in this case read or write access shall lead to the SDO abort transfer service (abort code: 0609 0011_h).

OBJECT DESCRIPTION

Index	1400 _h to 15FF _h
Name	RPDO communication parameter
Object code	RECORD
Data type	PDO communication parameter record
Category	Conditional; Mandatory for each supported RPDO

ENTRY DESCRIPTION

Sub-index	00 _h
Description	highest sub-index supported
Entry category	Mandatory
Access	const
PDO mapping	No
Value range	02 _h to 06 _h
Default value	No

Sub-index	01 _h
Description	COB-ID used by RPDO
Entry category	Mandatory
Access	rw; const, if COB-ID is not changeable
PDO mapping	No
Value range	<i>see value definition</i>
Default value	<i>see value definition</i>

Sub-index	02 _h
Description	transmission type
Entry category	Mandatory
Access	rw; const, if transmission type is not changeable
PDO mapping	No
Value range	<i>see value definition</i>
Default value	Profile- or manufacturer specific

Sub-index	03 _h
Description	inhibit time
Entry category	Optional
Access	rw; const, if inhibit time is not changeable
PDO mapping	No
Value range	<i>see value definition</i>
Default value	Profile- or manufacturer specific

Sub-index	04 _h
Description	compatibility entry
Entry category	Optional
Access	rw
PDO mapping	No
Value range	UNSIGNED8
Default value	Manufacturer specific

Sub-index	05 _h
Description	event-timer
Entry category	Optional
Access	rw; const, if event timer is not changeable
PDO mapping	No
Value range	<i>see value definition</i>
Default value	Profile- or manufacturer specific

Sub-index	06 _h
Description	SYNC start value
Entry category	Optional
Access	rw const, if SYNC start value is not changeable
PDO mapping	No
Value range	UNSIGNED8
Default value	Profile- or manufacturer specific

7.5.2.36 Object 1600_h to 17FF_h: RPDO mapping parameter

This object contains the mapping parameters for the PDOs the CANopen device is able to receive.

VALUE DEFINITION

Sub-index 00_h contains the number of valid object entries within the mapping record or a specific value (see Table 69), e.g. if MPDO is supported. The number of valid object entries shall be the number of the application objects that shall be received with the corresponding RPDO.

Table 69: RPDO mapping values

Value	Description
00 _h	Mapping disabled
01 _h	Sub-index 01 _h valid
02 _h	Sub-index 01 _h and 02 _h valid
03 _h	Sub-index from 01 _h to 03 _h valid
04 _h	Sub-index from 01 _h to 04 _h valid
.....
40 _h	Sub-index from 01 _h to 40 _h valid
41 _h	reserved
.....
FD _h	reserved
FE _h	SAM-MPDO
FF _h	DAM-MPDO

Sub-index from 01_h to 40_h contains the information of the mapped application objects. The object describes the content of the PDO by their index, sub-index and length (see Figure 69 and Figure 70). The length contains the length of the application object in bit. This may be used to verify the mapping.

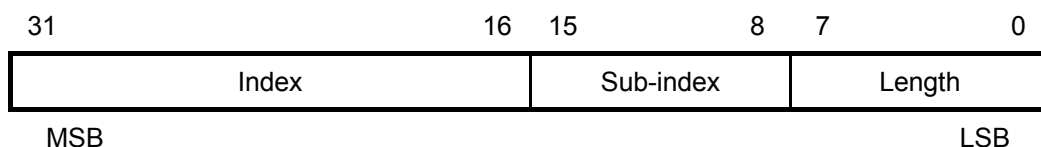

Figure 69: Structure of RPDO mapping

An attempt to change the value of an object entry to any value that is not supported shall be responded with the SDO abort transfer service. The cause for a not supported value could be the mapping (index and sub-index) of a non-existing application object, a wrong length for the mapped application object, or a wrong length for the PDO at all. The index and sub-index may

reference a simple data type (see Table 44) for the so-called dummy mapping. This may be used if no appropriate application object is available and to fill up the length of the RPDO to fit the length to the according TPDO.

The following procedure shall be used for re-mapping, which may take place during the NMT state Pre-operational and during the NMT state Operational, if supported:

1. Destroy RPDO by setting bit *valid* to 1_b of sub-index 01_h of the according RPDO communication parameter.
2. Disable mapping by setting sub-index 00_h to 00_h.
3. Modify mapping by changing the values of the corresponding sub-indices.
4. Enable mapping by setting sub-index 00_h to the number of mapped objects.
5. Create RPDO by setting bit *valid* to 0_b of sub-index 01_h of the according RPDO communication parameter.

If during step 3 the CANopen device detects that index and sub-index of the mapped object does not exist or the object cannot be mapped the CANopen device shall respond with the SDO abort transfer service (abort code: 0602 0000_h or 0604 0041_h).

If during step 4 the CANopen device detects that the RPDO mapping is not valid or not possible the CANopen device shall respond with the SDO abort transfer service (abort code: 0602 0000_h or 0604 0042_h).

If the CANopen device receives a PDO that is having more data bytes than the number of mapped data bytes is (length), then the CANopen device shall use the first data bytes up to the length and may be initiate the EMCY write service, if supported.

If a CANopen device receives a PDO that is having less data bytes than the number of mapped data bytes (length), then the CANopen device shall initiate the EMCY write service, if supported, with the error code 8210_h.

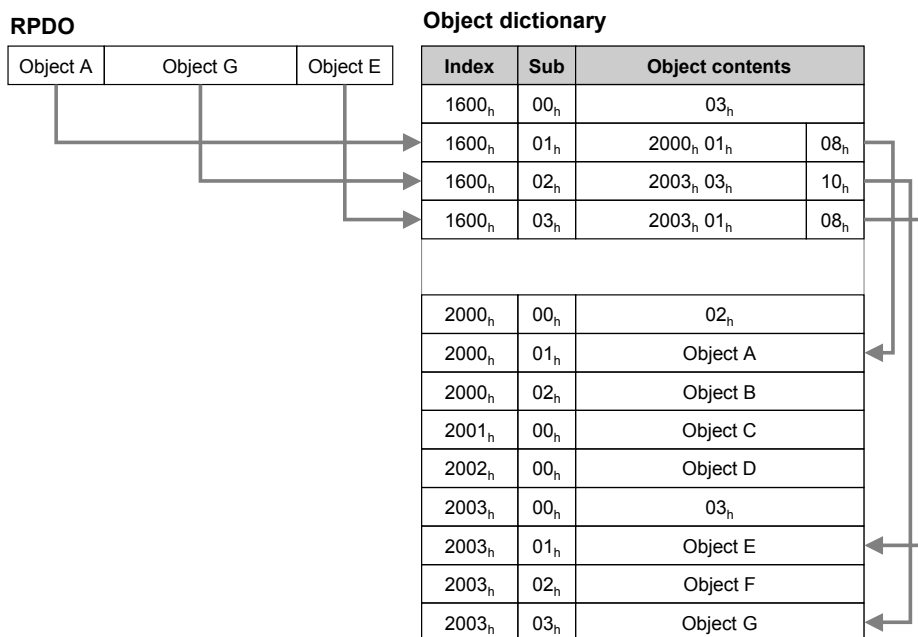

Figure 70: Principle of RPDO mapping

OBJECT DESCRIPTION

Index	1600 _h to 17FF _h
Name	RPDO mapping parameter
Object code	RECORD
Data type	PDO mapping parameter record
Category	Conditional; Mandatory for each supported PDO

ENTRY DESCRIPTION

Sub-index	00 _h
Description	number of mapped application objects in PDO
Entry category	Mandatory
Access	rw; const, if mapping is not changeable
PDO mapping	No
Value range	<i>see value definition</i>
Default value	profile- or manufacturer-specific

Sub-index	01 _h
Description	1 st application object
Entry category	Mandatory
Access	rw; const, if mapping entry is not changeable
PDO mapping	No
Value range	<i>see value definition</i>
Default value	profile- or manufacturer-specific

Sub-index	02 _h to 40 _h
Description	2 nd application object to 64 th application object
Entry category	Optional
Access	rw; const, if mapping entry is not changeable
PDO mapping	No
Value range	<i>see value definition</i>
Default value	profile- or manufacturer-specific

7.5.2.37 Object 1800_h to 19FF_h: TPDO communication parameter

This object contains the communication parameters for the PDOs the CANopen device is able to transmit.

VALUE DEFINITION

Sub-index 00_h contains the number of valid object entries within the record. Its value is at least 02_h. If inhibit time supported the value is 03_h and if event timer is supported the value is 05_h.

Sub-index 01_h contains the COB-ID of the TPDO (see Figure 71 and Table 70).

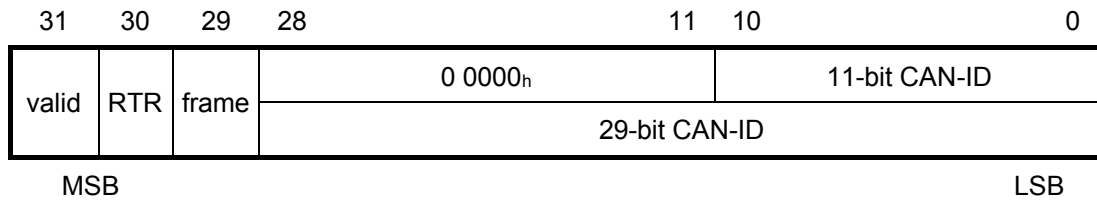

Figure 71: Structure of TPDO COB-ID

Table 70: Description of TPDO COB-ID

Bit(s)	Value	Description
valid	0 _b	PDO exists / is valid
	1 _b	PDO does not exist / is not valid
RTR	0 _b	RTR allowed on this PDO
	1 _b	no RTR allowed on this PDO
frame	0 _b	11-bit CAN-ID valid (CAN base frame)
	1 _b	29-bit CAN-ID valid (CAN extended frame)
29-bit CAN-ID	x	29-bit CAN-ID of the CAN extended frame
11-bit CAN-ID	x	11-bit CAN-ID of the CAN base frame

The bit valid (bit 31) allows selecting which TPDOs are used in the NMT state Operational. There may be PDOs fully configured (e.g. by default) but not used, and therefore set to "not valid" (deleted). The feature is necessary for CANopen devices supporting more than 4 TPDOs, because each CANopen device has only default CAN-IDs for the first four TPDOs in the generic pre-defined connection set. CANopen devices supporting the CAN base frame type only or do not support RTRs, an attempt to set bit 29 (frame) to 1_b or bit 30 (RTR) to 0_b is responded with the SDO abort transfer service (abort code: 0609 0030_h). It is not allowed to change bit from 0 to 29 while the PDO exists and is valid (bit 31 = 0_b). CANopen devices supporting the enabling (bit 31 = 0_b) and disabling (bit 31 = 1_b) of a TPDO only shall respond with the SDO abort transfer service (abort code: 0609 0030_h or 0800 000_h) on an attempt to change the values from bit 0 to bit 30.

If the CANopen device has implemented one or more device profiles the generic pre-defined connection set shall apply (see Table 67).

Table 71: Generic pre-defined connection set for TPDO

Index	Default value
1800 _h	CAN-ID: 180 _h + Node-ID frame: 0 _b RTR: profile- or manufacturer-specific valid: profile- or manufacturer-specific
1801 _h	CAN-ID: 280 _h + Node-ID frame: 0 _b RTR: profile- or manufacturer-specific valid: profile- or manufacturer-specific
1802 _h	CAN-ID: 380 _h + Node-ID frame: 0 _b RTR: profile- or manufacturer-specific valid: profile- or manufacturer-specific

Index	Default value
1803 _h	CAN-ID: 480 _h + Node-ID frame: 0 _b RTR: profile- or manufacturer-specific valid: profile- or manufacturer-specific
1804 _h to 19FF _h	CAN-ID: profile- or manufacturer-specific (see clause 7.3.5) frame: profile- or manufacturer-specific RTR: profile- or manufacturer-specific valid: 1 _b or defined by application profile

If the CANopen device has implemented an application profile the specific pre-defined connection set of that application profile shall apply.

Sub-index 02_h defines the transmission character of the TPDO (see Table 72). An attempt to change the value of the transmission type to any not supported value shall be responded with the SDO abort transfer service (abort code: 0609 0030_h).

Table 72: Description of TPDO transmission type

Value	Description
00 _h	synchronous (acyclic)
01 _h	synchronous (cyclic every sync)
02 _h	synchronous (cyclic every 2 nd SYNC)
03 _h	synchronous (cyclic every 3 rd SYNC)
04 _h	synchronous (cyclic every 4 th SYNC)
.....
F0 _h	synchronous (cyclic every 240 th SYNC)
F1 _h	reserved
.....
FB _h	reserved
FC _h	RTR-only (synchronous)
FD _h	RTR-only (event-driven)
FE _h	event-driven (manufacturer-specific)
FF _h	event-driven (device profile and application profile specific)

- Synchronous means that the PDO is transmitted after the SYNC. The CANopen device will start sampling of the data with the reception of the SYNC (see Figure 72). In case it is acyclic the CANopen device internal event is given and with the next SYNC the sampling is started and the PDO is transmitted afterwards. In case it is cyclic the sampling is started with the reception of every SYNC, every 2nd SYNC, every 3rd SYNC, and s.o. depending on the given value and the PDO is transmitted afterwards.

- RTR-only means that the PDO is not transmitted normally it shall be requested via RTR. In case it is synchronous the CANopen device will start sampling with the reception of every SYNC and then will buffer the PDO (see Figure 72). In case it is event-driven the CANopen device will start sampling with the reception of the RTR and will transmit the PDO immediately.
- Event-driven means that the PDO may be transmitted at any time based on the occurrence of a CANopen device internal event. The definition of the event does not fall into the scope of this specification and may be specified in device profiles and application profiles..

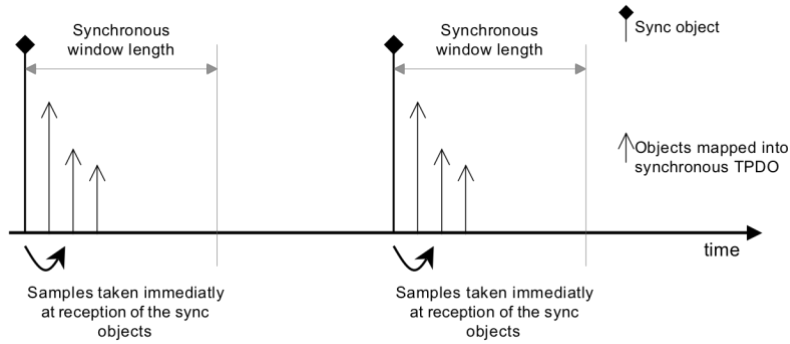

Figure 72: Bus synchronization and sampling

Sub-index 03_h contains the inhibit time. The time is the minimum interval for PDO transmission if the transmission type is set to FE_h and FF_h. The value is defined as multiple of 100 μs. The value of 0 shall disable the inhibit time. The value shall not be changed while the PDO exists (bit 31 of sub-index 01_h is set to 0_b).

Sub-index 04_h is reserved. It does shall not be implemented; in this case read or write access leads to the SDO abort transfer service (abort code: 0609 0011_h).

Sub-index 05_h contains the event-timer. The time is the maximum interval for PDO transmission if the transmission type is set to FE_h and FF_h. The value is defined as multiple of 1 ms. The value of 0 shall disable the event-timer.

Sub-index 06_h contains the SYNC start value. The SYNC start value of 0 shall indicate that the counter of the SYNC message shall not be processed for this PDO. The SYNC start value 1 to 240 shall indicate that the counter of the SYNC message shall be processed for this PDO. In case the counter of the SYNC message is not enabled (see 7.5.2.22) sub-index 06_h shall be ignored. The SYNC message of which the counter value equals the SYNC start value shall be regarded as the first received SYNC message. The value shall not be changed while the PDO exists (bit 31 of sub-index 01_h is set to 0_b).

NOTE if the CANopen device detects on switch into the NMT state operational that the SYNC counter value received is higher than the SYNC start value, then the CANopen device has to wait a full cycle until the correct SYNC counter is received.

OBJECT DESCRIPTION

Index	1800 _h to 19FF _h
Name	TPDO communication parameter
Object code	RECORD
Data type	PDO communication parameter record
Category	Conditional; Mandatory for each supported TPDO

ENTRY DESCRIPTION

Sub-index	00 _h
Description	highest sub-index supported
Entry category	Mandatory
Access	const
PDO mapping	No
Value range	02 _h to 05 _h

Sub-index	01 _h
Description	COB-ID used by TPDO
Entry category	Mandatory
Access	rw; const, if COB-ID is not changeable
PDO mapping	No
Value range	<i>see value definition</i>
Default value	see value definition

Sub-index	02 _h
Description	transmission type
Entry category	Mandatory
Access	rw; const, if transmission type is not changeable
PDO mapping	No
Value range	<i>see value definition</i>
Default value	profile- or manufacturer-specific

Sub-index	03 _h
Description	inhibit time
Entry category	Optional
Access	rw; const, if inhibit time is not changeable
PDO mapping	No
Value range	<i>see value definition</i>
Default value	profile- or manufacturer-specific

Sub-index	04 _h
Description	reserved
Entry category	Optional
Access	rw
PDO mapping	No
Value range	UNSIGNED8
Default value	manufacturer-specific

Sub-index	05 _h
Description	event timer
Entry category	Optional
Access	rw; const, if event timer is not changeable
PDO mapping	No
Value range	<i>see value definition</i>
Default value	profile- or manufacturer-specific

Sub-index	06 _h
Description	SYNC start value
Entry category	Optional
Access	rw; const, if SYNC start value is not changeable
PDO mapping	No
Value range	UNSIGNED8
Default value	profile- or manufacturer-specific

7.5.2.38 Object 1A00_h to 1BFF_h: TPDO mapping parameter

This object contains the mapping for the PDOs the device is able to transmit.

VALUE DEFINITION

Sub-index 00_h contains the number of valid object entries within the mapping record or a specific value (see Table 73), e.g. if MPDO is supported. The number of valid object entries shall be the number of the application objects that shall be transmitted with the corresponding TPDO.

Table 73: TPDO mapping values

Value	Description
00 _h	Mapping disabled
01 _h	Sub-index 01 _h valid
02 _h	Sub-index 01 _h and 02 _h valid
03 _h	Sub-index from 01 _h to 03 _h valid

Value	Description
04 _h	Sub-index from 01 _h to 04 _h valid
.....
40 _h	Sub-index from 01 _h to 40 _h valid
41 _h	reserved
.....
FD _h	reserved
FE _h	SAM-MPDO
FF _h	DAM-MPDO

Sub-index from 01_h to 40_h contains the information of the mapped application objects. The object describes the content of the PDO by their index, sub-index and length (see Figure 73 and Figure 74). The length contains the length of the application object in bit. This may be used to verify the mapping.

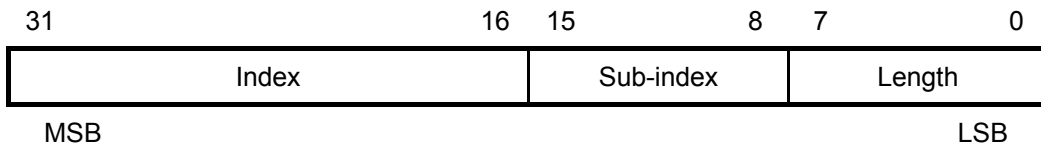

Figure 73: Structure of TPDO mapping

An attempt to change the value of an object entry to any value that is not supported shall be responded with the SDO abort transfer service. The cause for a not supported value could be the mapping (index and sub-index) of a non-existing application object, a wrong length for the mapped application object, or a wrong length for the PDO at all.

The following procedure shall be used for re-mapping, which may take place during the NMT state Pre-operational and during the NMT state Operational, if supported:

1. Destroy TPDO by setting bit *valid* to 1_b of sub-index 01_h of the according TPDO communication parameter.
2. Disable mapping by setting sub-index 00_h to 00_h.
3. Modify mapping by changing the values of the corresponding sub-indices.
4. Enable mapping by setting sub-index 00_h to the number mapped objects.
5. Create TPDO by setting bit *valid* to 0_b of sub-index 01_h of the according TPDO communication parameter.

If during step 3 the CANopen device detects that index and sub-index of the mapped object does not exist or the object cannot be mapped the CANopen device shall respond with the SDO abort transfer service (abort code: 0602 0000_h or 0604 0041_h).

If during step 4 the CANopen device detects that the RPDO mapping is not valid or not possible the CANopen device shall respond with the SDO abort transfer service (abort code: 0602 0000_h or 0604 0042_h).

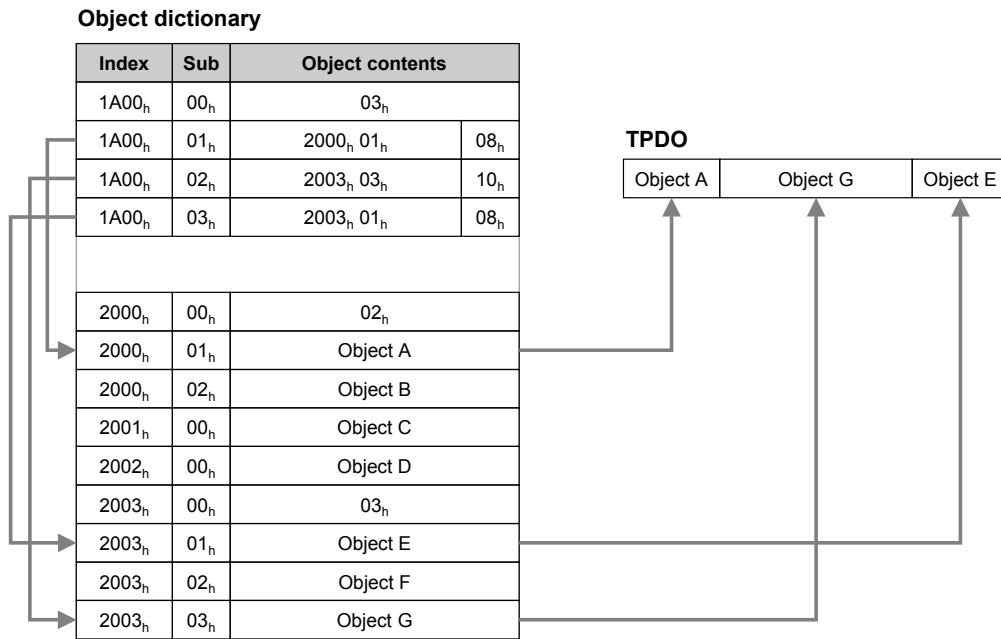

Figure 74: Principle of TPDO mapping

OBJECT DESCRIPTION

Index	1A00 _h to 1BFF _h
Name	TPDO mapping
Object code	RECORD
Data type	PDO mapping parameter record
Category	Conditional; Mandatory for each supported PDO

ENTRY DESCRIPTION

Sub-index	00 _h
Description	number of mapped application objects in TPDO
Entry category	Mandatory
Access	rw; const, if PDO mapping is not changeable
PDO mapping	No
Value range	<i>see value definition</i>
Default value	profile- or manufacturer-specific

Sub-index	01 _h
Description	1 st application object
Entry category	Mandatory
Access	rw; const, if PDO mapping entry is not changeable
PDO mapping	No
Value range	<i>see value definition</i>
Default value	profile- or manufacturer-specific

Sub-index	02 _h to 40 _h
Description	2 nd application object to 64 th application object
Entry category	Optional
Access	rw; const, if PDO mapping entry is not changeable
PDO mapping	No
Value range	<i>see value definition</i>
Default value	profile- or manufacturer-specific

7.5.2.39 Object 1FA0_h to 1FCF_h: Object scanner list

The producer of an SAM-MPDO uses the object scanner list to configure, which objects shall be transmitted.

VALUE DEFINITION

Each object entry describes an object that may be sent via the MPDO. It is possible to describe consecutive sub-indexes by setting the parameter block size to the number of sub-indexes that shall follow.

Object entries that are not configured shall have the value 0.

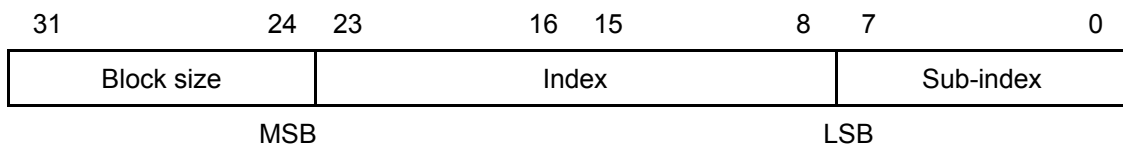

Figure 75: Object scanner list object entry

OBJECT DESCRIPTION

Index	1FA0 _h to 1FCF _h
Name	Object scanner list
Object code	ARRAY
Data type	UNSIGNED32
Category	Optional

ENTRY DESCRIPTION

Sub-index	00 _h
Description	Highest sub-index supported
Entry category	Mandatory
Access	const
PDO mapping	No
Value range	01 _h to FE _h
Default value	profile- or manufacturer-specific

Sub-index	01 _h
Description	Scan 1
Entry category	Mandatory
Access	rw; ro or const, if Scan entry is not changeable
PDO mapping	No
Value range	<i>see value definition</i>
Default value	profile- or manufacturer-specific

Sub-index	02 _h to FE _h
Description	Scan 2 to Scan 254
Entry category	Optional
Access	rw; ro or const, if Scan entry is not changeable
PDO mapping	No
Value range	<i>see value definition</i>
Default value	profile- or manufacturer-specific

7.5.2.40 Object 1FD0_h to 1FFF_h: Object dispatching list

The consumer of an SAM-MPDO uses the object dispatching list as a cross reference between the remote object of the producer and local object dictionary.

VALUE DEFINITION

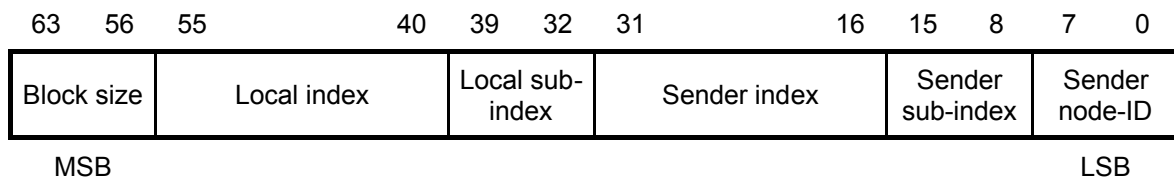

Figure 76: Object dispatching list object entry

Each object entry describes how the data of a received MPDO is transferred to the local object dictionary. If the flag field is 0 and the producer node-ID, the producer Index and producer sub-

index fit to the object entry, and then the data shall be written to the local object addressed by the values local index and local sub-index of that object entry.

The parameter block size allows the description of consecutive sub-indexes to be used. Example: if sub-index 1-9 of the sender shall be mapped to sub-index 11-19 of the receiver, this range is defined by

Sender Sub-index = 1
 Local Sub-index = 11
 Block Size = 9

Object entries that are not configured shall have the value 0.

OBJECT DESCRIPTION

Index	1FD0 _h to 1FFF _h
Name	Object dispatching list
Object code	ARRAY
Data type	UNSIGNED64
Category	Optional

ENTRY DESCRIPTION

Sub-index	00 _h
Description	Highest sub-index support
Entry category	Mandatory
Access	const
PDO mapping	No
Value range	01 _h to FE _h
Default value	profile- or manufacturer-specific

Sub-index	01 _h
Description	Dispatch 1
Entry category	Mandatory
Access	rw; ro or const, if dispatch entry is not changeable
PDO mapping	No
Value range	UNSIGNED64
Default value	profile- or manufacturer-specific

Sub-index	02 _h to FE _h
Description	Dispatch 2 to Dispatch 254
Entry category	Optional
Access	rw; ro or const, if dispatch entry is not changeable
PDO mapping	No
Value range	UNSIGNED64
Default value	profile- or manufacturer-specific

Annex A (informative)

Implementation Recommendations

When implementing the protocols, the following rules shall be obeyed to guarantee interoperability. These rules deal with the following implementation aspects:

Invalid COB's

A COB is invalid if it has a COB-ID that is used by the specified protocols, but it contains invalid parameter values according to the protocol specification. This may only be caused by errors in the lower layers or implementation errors. Invalid COB's shall be handled locally in an implementation specific way that does not fall within the scope of this specification. As far as the protocol is concerned, an invalid COB shall be ignored.

Time-out's

Since COB's may be ignored, the response of a confirmed service may never arrive. To resolve this situation, an implementation may, after a certain amount of time, indicate this to the service user (time-out). A time-out is not a confirmation of that service. A time-out indicates that the service has not completed yet. The application may deal with this situation. Time-out values are considered to be implementation specific and do not fall within the scope of this specification. However, it is recommended that an implementation provides facilities to adjust these time-out values to the requirements of the application.

PDO Transmission Type 0, 254, 255

Transmit PDOs with these transmission types may be sent immediately for transmission type 254 and 255 or with the first Sync for transmission type 0 after entering the operational state, if not specified differently in the corresponding profiles.

Overview object dictionary objects for communication

Table 74: Standard objects

Index	Object	Name	Data type	Acc. ²	M/O
1000 _h	VAR	device type	UNSIGNED32	ro	M
1001 _h	VAR	error register	UNSIGNED8	ro	M
1002 _h	VAR	manufacturer status register	UNSIGNED32	ro	O
1003 _h	ARRAY	pre-defined error field	UNSIGNED32	ro	O
1004 _h	reserved for compatibility reasons				
1005 _h	VAR	COB-ID SYNC	UNSIGNED32	rw	O
1006 _h	VAR	communication cycle period	UNSIGNED32	rw	O
1007 _h	VAR	synchronous window length	UNSIGNED32	rw	O
1008 _h	VAR	manufacturer device name	VIS-STRING	const	O
1009 _h	VAR	manufacturer hardware version	VIS-STRING	const	O
100A _h	VAR	manufacturer software version	VIS-STRING	const	O
100B _h	reserved for compatibility reasons				
100C _h	VAR	guard time	UNSIGNED16	rw	O
100D _h	VAR	life time factor	UNSIGNED8	rw	O

² Access type listed here may vary for certain sub-indices. See detailed object specification.

CANopen application layer and communication profile

100E _h	reserved for compatibility reasons				
100F _h	reserved for compatibility reasons				
1010 _h	ARRAY	store parameters	UNSIGNED32	rw	O
1011 _h	ARRAY	restore default parameters	UNSIGNED32	rw	O
1012 _h	VAR	COB-ID TIME	UNSIGNED32	rw	O
1013 _h	VAR	high resolution time stamp	UNSIGNED32	rw	O
1014 _h	VAR	COB-ID EMCY	UNSIGNED32	rw	O
1015 _h	VAR	Inhibit Time EMCY	UNSIGNED16	rw	O
1016 _h	ARRAY	Consumer heartbeat time	UNSIGNED32	rw	O
1017 _h	VAR	Producer heartbeat time	UNSIGNED16	rw	O
1018 _h	RECORD	Identity Object	IDENTITY (23 _h)	ro	M
1019 _h	VAR	Synchronous counter overflow value	UNSIGNED8	rw	O
Device configuration					
1020 _h	ARRAY	Verify configuration	UNSIGNED32	rw	O
EDS storage					
1021 _h	VAR	Store EDS	DOMAIN	rw	O
1022 _h	VAR	Storage format	UNSIGNED8	rw	O
OS command and prompt					
1023 _h	RECORD	OS command	COMMANDPAR (25 _h)	rw	O
1024 _h	VAR	OS command mode	UNSIGNED8	wo	O
1025 _h	RECORD	OS debugger interface	OS DEBUG (24 _h)	rw	O
1026 _h	ARRAY	OS prompt	UNSIGNED8	rw	O
Modular devices					
1027 _h	ARRAY	Module list	UNSIGNED16	ro	M/O***
Emergency and error behavior					
1028 _h	ARRAY	Emergency consumer	UNSIGNED32	rw	O
1029 _h	ARRAY	Error behavior	UNSIGNED8	rw	O
102A _h		reserved			
.....
11FF _h		reserved			
Server SDO parameter					
1200 _h	RECORD	1 st SDO server parameter	SDO PARAM (22 _h)	ro	O
1201 _h	RECORD	2 nd SDO server parameter	SDO PARAM (22 _h)	rw	M/O**
.....
127F _h	RECORD	128 th SDO server parameter	SDO PARAM (22 _h)	rw	M/O**
Client SDO parameter					
1280 _h	RECORD	1 st SDO client parameter	SDO PARAM (22 _h)	rw	M/O**

CANopen application layer and communication profile

1281 _h	RECORD	2 nd SDO client parameter	SDO PARAM (22 _h)	rw	M/O**
.....
12FF _h	RECORD	128 th SDO client parameter	SDO PARAM (22 _h)	rw	M/O**
1300 _h		reserved			
.....
13FF _h		reserved			
RPDO communication parameter					
1400 _h	RECORD	1 st RPDO communication parameter	PDO COMMPAR (20 _h)	rw	M/O*
1401 _h	RECORD	2 nd RPDO communication parameter	PDO COMMPAR (20 _h)		M/O*
.....
15FF _h	RECORD	512 th RPDO communication parameter	PDO COMMPAR (20 _h)	rw	M/O*
RPDO mapping parameter					
1600 _h	RECORD	1 st RPDO mapping parameter	PDO MAPPING (21 _h)	rw	M/O*
1601 _h	RECORD	2 nd RPDO mapping parameter	PDO MAPPING (21 _h)	rw	M/O*
.....
17FF _h	RECORD	512 th RPDO mapping parameter	PDO MAPPING (21 _h)	rw	M/O*
TPDO communication parameter					
1800 _h	RECORD	1 st TPDO communication parameter	PDO COMMPAR (20 _h)	rw	M/O*
1801 _h	RECORD	2 nd TPDO communication parameter	PDO COMMPAR (20 _h)	rw	M/O*
.....
19FF _h	RECORD	512 th TPDO communication parameter	PDO COMMPAR (20 _h)	rw	M/O*
TPDO mapping parameter					
1A00 _h	RECORD	1 st TPDO mapping parameter	PDO MAPPING (21 _h)	rw	M/O*
1A01 _h	RECORD	2 nd TPDO mapping parameter	PDO MAPPING (21 _h)	rw	M/O*
.....
1BFF _h	RECORD	512 th TPDO mapping parameter	PDO MAPPING (21 _h)	rw	M/O*
Multiplex PDO					
1FA0 _h	ARRAY	Object scanner list	UNSIGNED32	rw	O
.....
1FCF _h	ARRAY	Object scanner list	UNSIGNED32	rw	O
1FD0 _h	ARRAY	Object dispatching list	UNSIGNED64	rw	O
.....
1FFF _h	ARRAY	Object dispatching list	UNSIGNED64	rw	O

* If a CANopen device supports PDOs, the according PDO communication parameter and PDO mapping object entries in the object dictionary are mandatory. These may be ro.

** If a CANopen device supports SDOs, the according SDO parameters in the object dictionary are mandatory.

*** see object definition.

Public Available Specification

CiA 301

Version 4.2.0

CANopen application layer and communication profile

Corrigendum 1

August 11, 2010



Page 68, Figure 35:

Add the following definition in the figure's legend (directly after the drawing):

L: Data Length Code of the related CAN data frame

Page 72, Figure 38:

Add in the figure's legend in the third bullet after "Manufacturer-":

or profile-

Page 77, Figure 39, Figure 40; page 78, Figure 41, Figure, 42, Figure 43:

Add the following definition in the figure's legend (directly after the drawing):

Node-ID:

0: all devices shall perform the commended transition

1 to 127: only the device with this node-ID shall perform the commended transition

Page 84, 7.3.2.2.1:

Add to second bullet "Reset application" in between the first and the second sentence the following:

The node-ID and bit-rate settings are set to their power-on values.

Page 91, Table 44:

Add the following lines after "Index 0023_h":

0024 _h	DEFSTRUCT	OS debug record
0025 _h	DEFSTRUCT	OS command record

Page 91, Table 44:

Replace the "0024_h – 003F_h" by:

0026_h – 003F_h

Page 96, Figure 52; page 97, Figure 53:

Remove MSB value "32" by:

31

Page 97, 7.5.3.4:

Add in the NOTE in the first bullet after "01_h":

to FE_h

Page 103, 7.5.2.13; page 106, 7.5.2.14:

Replace "abort code: 0800 002x_h" by:

abort code: 0800 0020_h, 0609 0030_h, or 0800 0000_h

Page 126, 7.5.2.32:

Add in the ENTRY DESCRIPTION table for sub-index 01_h in the Default value line after 00_h:

or profile-specific

Page 121, 7.5.2.29; page 123, 7.5.2.30:

Replace in the ENTRY DESCRIPTION table for sub-index 00_h in the Default value line “No” by:

Manufacturer-specific

Page 133, 7.5.2.35:

Replace in the ENTRY DESCRIPTION table for sub-index 00_h in the Default value line “No” by:

Profile- or manufacturer-specific

Page 140, 7.5.2.37:

Add in the ENTRY DESCRIPTION table for sub-index 00_h the Default value line:

Default value	Profile- or manufacturer-specific
---------------	-----------------------------------

Public Available Specification

CiA 301

Version 4.2.0

CANopen application layer and communication profile

Corrigendum 2

February 21, 2011



Page 89, Table 42:

Change heading of the second column from “Comments” to:

Description

Page 89, Table 42:

Change in 4th row and second column the word “FLOAT” to:

REAL32

Page 89, Table 42:

Change in 6th row and second column the word “FLOAT” to:

REAL32

Page 89, 7.4.4:

Change the word “FLOAT” to:

REAL32

Public Available Specification

CiA 301

Version 4.2.0

CANopen application layer and communication profile

Corrigendum 3

July 15, 2011



Page 70, Table 26:

Add the following Emergency error codes:

8F01 _h	Life guard error <i>or</i> heartbeat error caused by node-ID 1
<i>to</i>	<i>to</i>
8F7F _h	Life guard error <i>or</i> heartbeat error caused by node-ID 7F

Page 71, 7.2.7.1:

Replace in the numbered list in the first entry (“0.”) “After initialization” by:

After NMT state INITIALISATION

Delete in the numbered list in the first entry (“0.”) “if no error is detected. No error message is sent”

Page 83, 7.3.2.1:

Add the following NOTE after Figure 48:

NOTE An NMT state transition is also triggered locally depending on the configuration of error behavior object (for details see 7.5.2.32).

Page 85, 7.3.2.2.4:

Add after the first paragraph the following paragraph:

The device transiting into NMT state Stopped shall not transmit an SDO abort transfer protocol.

Add to the NOTE after “1003_h”:

(this is possible only in NMT state Pre-operational or NMT state operational)

Page 95, 7.5.1:

Add after the ENTRY DESCRIPTION table:

A parameter with an access attribute of “wo” shall not be mapped into TPDOs; a parameter with an access attribute of “ro” shall not be mapped into RPDOs.

Page 98, 7.5. 2.4:

Replace the Default value of sub-index 00_h in the ENTRY DESCRIPTION table by:

No

Page 116, 7.5.2.24:

Replace in the third bullet “settings is” by:

settings are

Page 117, 7.5.2.25:

Replace in the Table OBJECT DESCRIPTION the Data type attribute by:

UNSIGNED8

Replace in the Table ENTRY DESCRIPTION the Value range attribute by:

See Table 60

Page 118, 7.5.2.26:

Replace in the Table ENTRY DESCRIPTION the Value range attribute for sub-index 01_h and 03_h by:

Manufacturer-specific

Page 120, 7.5.2.28:

Replace in the Table ENTRY DESCRIPTION the Value range attribute for sub-index 01_h and 03_h by:

Manufacturer-specific

Page 126, 7.5.2.32:

Replace in the Table ENTRY DESCRIPTION the last sub-table by:

Sub-index	02 _h to 7E _h
Description	Profile-specific error 1 to 125
Entry category	Optional
Access	rw; const, if error behavior is not changeable
PDO mapping	No
Value range	<i>see value definition</i>
Default value	Profile-specific

Sub-index	80 _h to FE _h
Description	Manufacturer-specific error 1 to 127
Entry category	Optional
Access	rw; const, if error behavior is not changeable
PDO mapping	No
Value range	<i>see value definition</i>
Default value	Manufacturer-specific