

ACU-RITE®

ACU-RITE® III

DIGITAL READOUT SYSTEM

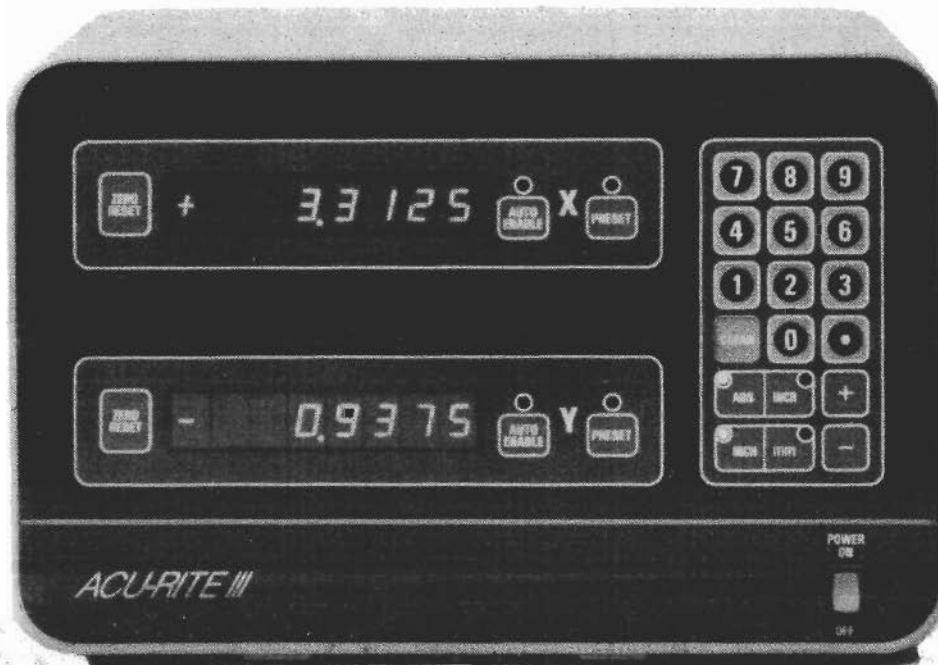

OPERATOR'S MANUAL

HANSON

CONTENTS

	Page		
General Information	ii	SECTION 4 MACHINE TOOL ERROR	
Warranty to the User	ii	COMPENSATION	
FCC Compliance Statement	ii	4.1 Why Errors Occur	4-1
SECTION 1 INTRODUCTION		4.2 How To Measure Abbe' Errors	4-1
1.1 How To Use This Manual	1-1	4.2.1 Step Gage Method	4-1
1.2 System Description	1-1	4.2.2 Simplified Method	4-2
1.3 Features You Should Know About	1-1	4.3 Error Correction Procedure	4-3
1.3.1 Absolute/Incremental Measurement		SECTION 5 MAINTENANCE	
Mode	1-1	5.1 General	5-1
1.3.2 Inch-to-Millimeter Direct Conversion .	1-2	5.2 Cover Removal Procedure	5-1
1.3.3 Preset Key	1-2	5.3 Preliminary Troubleshooting	5-1
1.3.4 Machine Tool Geometry (Abbé)		5.4 System Troubleshooting	5-1
Error Compensation	1.2	ILLUSTRATIONS	
1.3.5 Large Scale Integrated (LSI) Circuitry .	1-2	Figure 1-1 ACU-RITE Digital Position Readout	
1.3.6 L.E.D. Display	1-2	and Scale Assemblies	1-1
1.3.7 Auto Enable	1-2	Figure 2-1 Console Electrical Connections	2-1
1.3.8 Radius/Diameter	1-2	Figure 2-2 Internal Switch and Jumper	
1.3.9 Tool Offset Dimension	1-2	Locations on Axis Board	2-2
1.3.10 Tactile Keyboard	1-2	Figure 2-3 Decimal Point Jumper Placement	
1.3.11 Membrane Control Panel	1-2	on Axis Board Viewed from Back	
1.3.12 Switchable Resolution	1-2	of Counter	2-3
1.3.13 Other Features	1-3	Figure 2-4 Triple Axis Board with High/Low	2-5
1.4 Specifications	1-3	Figure 3-1 Control Panel	3-1
1.4.1 Console	1-3	Figure 3-3 Table Travel Polarities (Direction)	3-3
1.4.2 Scale Assemblies	1-4	Figure 3-4 Console Status: Power On	3-4
SECTION 2 INSTALLATION		Figure 3-5 Console Status: Zero Reset	3-4
2.1 Installation of Console	2-1	Figure 3-6 Console Status: Fault Indicator	3-4
2.1.1 General	2-1	Figure 3-7 Workpiece for Incremental	
2.1.2 Console Location	2-1	Procedure	3-4
2.2 Electrical Connections	2-1	Figure 3-8 Console Status: Preset Value Display ..	3-5
2.2.1 Internal Switch Settings	2-3	Figure 3-9 Console Status: Clearing Preset	
2.2.2 Switchable Radius/Diameter Feature ..	2-4	and Display	3-5
2.2.3 Direction Polarity	2-4	Figure 3-10 Console Status: Digital Display	3-5
SECTION 3 OPERATION		Figure 3-11 Console Status: Preset Entry,	
3.1 General	3-1	Incremental Mode	3-5
3.2 Control Panel Description	3-1	Figure 3-12 Workpiece for Preset Procedure A ...	3-5
3.2.1 Fault Indicator	3-1	Figure 3-13 Workpiece for Preset Procedure B ...	3-6
3.2.2 L.E.D. Display	3-2	Figure 3-14 Workpiece for Tool Offset	
3.2.3 ZERO RESET Key	3-2	Procedure A	3-6
3.2.4 AUTO ENABLE Key	3-2	Figure 3-15 Workpiece for Tool Offset	
3.2.5 PRESET Key	3-2	Procedure B	3-7
3.2.6 Digit Keyboard	3-2	Figure 3-16 Workpiece for Tool Offset	
3.2.7 CLEAR Key	3-2	Procedure C	3-7
3.2.8 ABS-INCR Keys	3-2	Figure 3-17 Workpiece for Tool Offset	
3.2.9 INCH-mm Keys	3-2	Procedure D	3-7
3.2.10 Plus-Minus Keys	3-2	Figure 3-18 Console Status: Absolute Mode	3-8
3.2.11 Including Tool Offset Dimensions	3-3	Figure 3-19 Console Status: Preset Entry,	
3.3 Operating Procedures	3-3	Absolute Mode	3-8
3.3.1 Setup	3-4	Figure 3-20 Console Status: Clearing Preset in	
3.3.2 Incremental Mode Operation	3-4	Absolute Mode	3-8
3.3.3 Preset Operation	3-4	Figure 3-21 Console Status: Digital Display in	
3.3.3.1 Example Procedure A	3-5	Absolute Mode	3-8
3.3.3.2 Example Procedure B	3-6		
3.3.4 Tool Offset Operation	3-6		
3.3.4.1 Example Procedure A	3-6		
3.3.4.2 Example Procedure B	3-6		
3.3.4.3 Example Procedure C	3-7		
3.3.4.4 Example Procedure D	3-7		
3.3.5 Absolute Mode Operation	3-7		
3.3.6 Combined-Mode Operation	3-8		
3.4 How To Use Auto Enable	3-9		

Figure 3-22	Workpiece for Combined Mode Procedure	3-8
Figure 3-23	Console Status: Auto Enable	3-9
Figure 4-1	Exaggerated Abbé Error Curve of Travel on a Milling Machine with an Overhanging Table	
Figure 4-2	Example of Measuring Set-up Using Step Gage as a Standard to Measure Abbe' Error	4-2
Figure 4-3	Simplified Set-up for Measuring Abbe' Error	4-2
Figure 5-1	Test Point on Display Board	5-1
Figure 5-2	Test Point on Power Supply Board	5-1

TABLES

Table 1-1	Display and Resolution of Switchable Resolution Setting	1-2
Table 2-1	Internal Switch Settings	2-3
Table 2-2	Round-off in mm/inch Conversion	2-4
Table 4-1	Standard and Displayed Measurements (Inch)	4-2
Table 4-2	Switch Assembly S1 Settings for Error Connection and Diameter Readout Selection	4-4
Table 5-1	System Troubleshooting	5-2

SECTION 1 INTRODUCTION

1.1 HOW TO USE THIS MANUAL

This manual has been prepared to familiarize you with all parts of the system and the various operating procedures you'll need to use. Other sections of the manual include:

2. Installation—How to install the console and check out the system. To install A-R/5 and Mini-Scale assemblies, see respective manuals.
3. Operation—How to use the console controls and operate the system, with examples and detailed procedures.
4. Machine Error Compensation—What machine geometry errors are, and how to determine and correct them. Plus how to use the system to calibrate a machine tool. Functions of internal switches are also described.
5. Maintenance—The nature of system problems and how to correct them using a troubleshooting table and other procedures.

Refer to CONTENTS for locating specific procedures. You will not find information on electronic parts replacement or repair in this manual. In case of malfunctions in the electronic network that cannot be remedied using the troubleshooting guide contact your ACU-RITE® distributor service representative.

1.2 SYSTEM DESCRIPTION

The system, as shown in Figure 1-1, includes two basic components: the ACU-RITE III digital position readout (DRO or console), for control and display, and ACU-RITE scale assemblies installed on one or more axes of your machine to detect and measure table movement.

Available as a one-, two-, or three-axis unit, the ACU-RITE III DRO contains solid-state electronics for coordinate presetting, tool offsetting, absolute and incremental locating, and readout.



Figure 1-1. ACU-RITE digital Position Readout and Scale Assemblies: A-R/5 10 μm (.0005"), 5 μm (.0002"), and Mini-Scale 10 μm (.0005"), 5 μm (.00025"), 2 μm (.0001"), and 1 μm (.00005")

A-R 5, A-R/1 and Mini-Scale—scale assemblies consist of an ACU-RITE chrome-line glass scale, protective housing and electronic reading head (also called a “transducer”). A cable from the reading head is connected to the rear of the console. See respective installation procedures in separate manuals for A-R/1, A-R/5 and Mini-Scale assemblies. Section 3, OPERATION, describes in detail how the system functions.

1.3 FEATURES YOU SHOULD KNOW ABOUT

Below are descriptions of the standard features that come with your system. In addition, optional features, which you may not have on your system, are also described.

1.3.1 Absolute/Incremental Measurement Modes

The system measures in two ways, or modes: the *incremental* measurement mode and the *absolute* measurement mode.

The incremental mode is used when you want the system to measure and display point-to-point table positions. After you've moved the table from one point to another, just reset to zero and continue to the next step. The *preset* function allows you to preset your console to any value. Preset is also used for tool offset (radius or diameter) by adding the preset value to or subtracting it from the incremental measurement. At any time you can recall the preset or offset dimension on the absolute or incremental register to the display by pushing (lighting) the PRESET key again. The associated sign indicates whether you added (+) or subtracted (–) the preset value the last time you used an offset.

In the absolute mode, the system keeps track of the distance the table has moved in a given axis from the original zero starting position, no matter how many incremental steps you've made. This absolute distance is displayed the instant you push (lighting) the ABS key.

Full operating descriptions are found in Section 3, OPERATION.

1.3.2 Inch-to-Millimeter Direct Conversion

This feature allows you to machine in either inch or millimeter dimensions and by pushing either the INCH or mm key on the DRO console, converts from one to the other without losing your zero reference, preset values or displayed dimensions.

1.3.3 Preset Key

You can preset your coordinate dimensions into the memory and recall them to the display at any time, using the PRESET key. Subtract from or add to coordinates at any time without presetting again.

1.3.4 Machine Tool Geometry (Abbé) Error Compensation

Every machine tool is subject to geometric error due to the force of gravity, particularly when machining heavy or overhanging workpieces. The ACU-RITE III system can compensate for certain types of errors in increments of ± 15 parts per million, up to about ± 458 ppm.

Section 4 is devoted to a detailed explanation of Abbé error.

1.3.5 Large Scale Integrated (LSI) Circuitry

All of the complex electronic circuitry of the ACU-RITE III DRO is incorporated into LSI chips. The DRO has completely interchangeable printed circuit boards and modules.

1.3.6 L.E.D. Display

The seven-decade (and plus/minus) light-emitting diode display is visible within a 120-degree viewing angle and is easy to see at 20 feet or more. As the reading head moves with relation to the scale, the numbers change instantaneously to indicate exact position.

1.3.7 Auto Enable

The auto enable feature is provided on all counters. However, it will be active only if your scale is equipped with a fiducial trigger output (FTO).

Auto enable establishes a permanent zero reference for your machine table travel. It's handy for either of the two following situations (see also How To Use Auto Enable in Section 3, OPERATION):

- a. When machining identical production parts, using a fixture, auto enable provides a distance reference to your first machining operation so your location is exact each time. This saves time, eliminates positioning errors and also eliminates the need to use a surface of the part as a reference location.
- b. On occasion, a part may have to be left on the machine overnight or through the weekend. Auto enable keeps you from losing your place. Simply move the table back to the closest zero location, then move the known distance to your next machining location according to dimensions on your workprint.

1.3.8 Radius/Diameter

This feature doubles all measurements for the operator-selected axis and the displayed value will be the actual diameter reading applicable to the cross-slide motion of a lathe or cylindrical grinder.

1.3.9 Tool Offset Dimensions

Use of the digit keys and the plus and minus keys make the console capable of arithmetic calculations. You can add a dimension to or subtract it from the incremental measurement in the display at any time. Usually, this capability is used for including a tool offset (diameter or radius) into the print dimension to be machined.

1.3.10 Tactile Keyboard

The easy to clean membrane keyboard has embossed finger locators and a tactile response to make its use easy and error free. When a key is pressed a click can be felt confirming an entry.

1.3.11 Membrane Control Panel

Features of the membrane control panel are shown in Figure 3-1 and described in Section 3.2, Control Panel Description.

1.3.12 Switchable Resolution (Optional)

A switch on the back panel (labeled “HIGH—MEDIUM—LOW”) provides a convenient method of adjusting the display for use with scales of different resolution. The switch positions change the display of the least-significant digit (the last digit position on the right side of the display) as shown in Table 1-1.

The resolution displayed for each type of scale with the switch in the "HIGH," "MEDIUM," or "LOW" position is also given in Table 1-1.

1.3.13 Other Features

A fault indicator, a lighted mark in the sign display, indicates a power interruption or an improper signal to the console (e.g., excessive slew speed). Also, the console faceplate withstands years of grease and dirt—you can restore its finish with the wipe of a cloth.

There are operating descriptions of all of these features elsewhere in this manual.

1.4 SPECIFICATIONS

1.4.1 Console

Display	Full 7 decades of 7 segment LEDs, long life, readable to over 20 feet at 120° viewing angle, plus and minus sign and fault indication.
Circuitry	Integrated Circuitry, including LSI.
Capacity	One, two or three axes of 7 decades each.
Inputs	TTL compatible quadrature square waves (input noise filtered by signal sampling technique).
Front Panel Controls	ON/OFF switch. ZERO RESET key, mm-INCH selector keys, PRESET keys, digit keyboard, Plus-Minus keys, CLEAR key, ABS key, INCR key and AUTO ENABLE keys.

Rear Panel Controls

External Connections	One, two or three signal inputs.
Diameter/Radius Display	Selectable diameter or radius display.
Display Selector (Optional)	Select high, medium or low display.
Fault Indicator	Power interruptions, excessive count rate and scale or counter malfunction are flagged in the display.
Linear Correction	Output count can be modified in increments of ± 15 parts per million up to a maximum of ± 458 parts per million to compensate for some types of machine or temperature error.
Power	100VAC, 115VAC, 220VAC, and 240 VAC, 50-60Hz.
Ambient Temperature Resolution	0°C (32°F) to 50°C (122°F) DRO is usable (without modification) and internally switch-settable for the following scale resolutions: 10 μ m(.0005") 5 μ m(.00025") (for diameter readout) 2 μ m(.0001") 1 μ m(.00005")
Dimensions	W326mm x H211mm x D152mm (W12.8" x H8.3" x D6")
Weight (net)	6.2Kg (13.6lb)

TABLE 1-1. Display and Resolution of Switchable Resolution Setting

	High	Medium	Low
Display	No change	0, 1, 2, 3 are displayed as "0." 4, 5, 6, 7, 8, 9 are displayed as "5."	Least significant digit is not displayed.
Scale Resolution			
10 μ m(.0005")	.0005"/.01mm	.0005"/.05mm	.001"/.1mm
5 μ m(.00025") (linear)	.0002"/.005mm	.0005"/.005mm	.001"/.01mm
2 μ m(.0001")	.0001"/.002mm	.0005"/.005mm	.001"/.01mm
1 μ m(.00005")	.00005"/.001mm	.0005"/.005mm	.0001"/.01mm

1.4.2 Scale Assemblies

DISPLACEMENT RANGES - Acu-Rite Scale Assemblies

Measuring Range mm (Inches)	AR-5	AR-5	MINI	MINI	MINI	MINI
	10 μ m (.0005")	5 μ m (.0002")	10 μ m (.0005")	5 μ m (.00025")	2 μ m (.0001")	1 μ m (.00005")
	3820		3831	3832	3807	3834
50 (2")	—	—	382102	383202	380702	383402
100 (4")	—	—	383104	383204	380704	383404
150 (6")	—	—	383106	383206	380706	383406
200 (8")	—	—	383108	383208	380708	383408
250 (10")	—	—	383110	383210	380710	383410
300 (12")	382012	382612	383112	383212	380712	383412
350 (14")	—	—	383114	383214	380714	383414
400 (16")	382016	382616	383116	383216	380716	383416
450 (18")	382018	382618	383118	383218	380718	383418
500 (20")	382020	382620	383120	383220	380720	383420
600 (24")	382024	382624	383124	383224	380724	383424
650 (26")	382026	382626	383126	383226	380726	383426
750 (30")	382030	382630	383130	383230	380730	383430
800 (31.5")	—	—	383131	383231	—	—
813 (32")	—	—	383132	—	—	—
889 (35")	—	—	383135	—	—	—
900 (36")	382036	382636	383136	383236	380736	383436
1000 (40")	—	—	383140	383240	380740	383440
1050 (42")	382042	382642	383142	383242	380742	—
1225 (48")	382048	382648	383248	380748	—	—
1375 (54")	382054	382654	383154	383254	380754	—
1525 (60")	382060	382660	383160	383260	380760	—
1625 (65")	382065	382665	—	—	—	—
1800 (72")	382072	382672	—	—	—	—
2000 (80")	382080	382680	—	—	—	—
2250 (90")	382090	382690	—	—	—	—
2550 (100")	382091	382691	—	—	—	—
2800 (110")	382092	382692	—	—	—	—
3050 (120")	382093	382693	—	—	—	—

AR-10 PLUS SPECIFICATIONS

MECHANICAL

Grating Pitch	100 μ m
Accuracy	$\pm 5 \mu$ m (.0002") within any random 39" (1M) section of measuring length
Max. Slew Speed	190 ft min (60 M/min); 40 in/sec (1000 min/sec)
Max. Acceleration	98 ft/sec ² (30 M/sec ²)
Req. Moving Force	≤ 3 lbs (15 N)
Operating Temp.	32-140°F (0°-60°C)
Storage Temp.	-4°-158°F (-20°-70°C)
Weight	4 lbs (1.8 kg) + 2.2 lbs/ft 3.3 kg/M of measuring length
Connecting Cable	10 ft (3M) with connector and armored cable
Max. Cable Length	65 ft. (20M)
Measuring Lengths (standard)	10 ft. (3M) through 65 ft (19.8M)

ELECTRICAL

Light Source	Miniature lamp 5VDC/.6W
Operating Voltage	5 V \pm 5%, 140 mA
Output Signals	
Incremental	2 Sinusoidal Signals, Channels A and B
Reference	1 Trigger signal Fiducial (FTO) channel
Signal Levels (1K Ohm Load)	A and B 7-16 μ mApp FTO 2-8 μ mApp
Max. Cable Length At Output of A/D Box	150 ft. (50 M)

STANDARD CABLE CONNECTOR

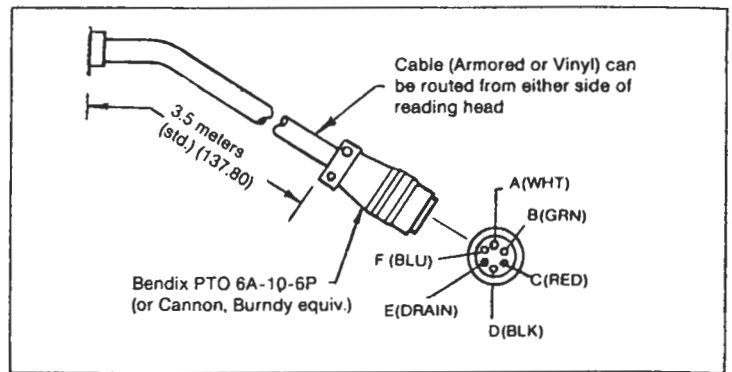

ENGINEERING & QUALITY

Resolution μ m (Inches)	AR-5	MINI	AR-5	MINI	AR-1	MINI	MINI
	3820	3831	3826	3832	3833	3807	3834
	10 μ m (.0005")	5 μ m (.0002")	5 μ m (.0002")	5 μ m (.0002")	2 μ m (.0001")	2 μ m (.0001")	1 μ m (.00005")
Line Density lines/mm (lines/inch)	25 (635)	25 (635)	25 (635)	25 (635)	62.5 (1588)	62.5 (1588)	125 (3175)
Accuracy μ m in 50 mm (Inches) (2 Inches)	—	—	—	—	$\pm 2 \mu$ m ($\pm .00008$)	$\pm 2 \mu$ m ($\pm .00008$)	$\pm 1.5 \mu$ m ($\pm .00006$)
μ m in 250 mm (Inches) (10 Inches)	—	—	—	—	$\pm 4 \mu$ m ($\pm .00015$)	$\pm 4 \mu$ m ($\pm .00015$)	$\pm 2.5 \mu$ m ($\pm .0001$)
μ m in 1000 mm (Inches) (40 Inches)	$\pm 10 \mu$ m ($\pm .0004$)	$\pm 10 \mu$ m ($\pm .0004$)	$\pm 10 \mu$ m ($\pm .0004$)	$\pm 10 \mu$ m ($\pm .0004$)	$\pm 5 \mu$ m ($\pm .0002$)	$\pm 5 \mu$ m ($\pm .0002$)	$\pm 5 \mu$ m ($\pm .0002$)
Slew Speed mm per sec (Inches)	1000 (40)	1000 (40)	1000 (40)	1000 (40)	500 (20)	500 (20)	250 (10)

STANDARD SPECIFICATIONS - Acu-Rite Scale Assemblies:

Repeatability	Within one resolution count (all scales)
Backlash	1.5 μ m (.00006) (all scales)
Operating Conditions	0°C to 50°C (32°F to 122°F) 25% to 95% relative humidity (non-condensing)
Storage Conditions	-40°C to 65°C (-4°F to 149°F) 20% to 95% relative humidity (non-condensing)

ELECTRICAL CHARACTERISTICS

TTL compatible. Transistor collector output with internal pull-up resistor to Vcc.

Logic "1" level = pull-up to Vcc through a resistor.

Pull-up resistors

Signal outputs = 900 \pm 25% ohms
Fiducial outputs = 1.8K \pm 25% ohms

Logic "0" levels

Signal outputs = -0.4 Vdc to 0.5 Vdc at -7mA
Fiducial outputs = -0.4 Vdc to 0.5 Vdc at -2mA

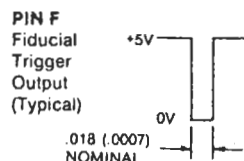
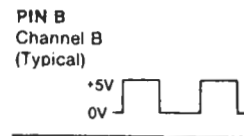
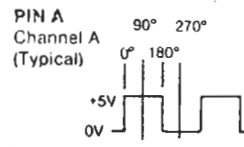

PIN	INPUT/OUTPUT
A	Channel "A" square wave signal
B	Channel "B" square wave signal in quadrature (90° nominal phase relationship) with channel "A" signal
C	Vcc + 5.1 \pm .1 Vdc power, 200mA max
D	Common (power supply and signal return)
E	Shield, reading head case ground
F	Fiducial trigger output signal (when provided)

SECTION 2 INSTALLATION

2.1 INSTALLATION OF CONSOLE

2.1.1 General

Console installation procedures consist of locating the console on one of two types of stands: machine-mounted or floor-mounted. Specific assembly instructions are contained in the kits.

This section includes procedures for making electrical connections and internal switch settings after the console has been mounted.

Separate installation instructions for the A-R/1, A-R/5 and Mini-Scale are packaged with the scales. Procedures for checking the system with your machine tool in preparation for operation are included in the operator's manual for each scale.

2.1.2 Console Location

When selecting the proper location for the console, be sure of the following for safety and convenience:

- The operator can easily reach the panel controls.
- The console is mounted at eye level for comfortable reading of the display and controls.
- There is no interference with operation or loading of the machine tool.
- The console is located away from coolant splash and flying chips.

2.2 ELECTRICAL CONNECTIONS

CAUTION

Do not operate the system with a supply voltage other than that marked on the console nameplate. Incorrect voltage can damage the system.

- Refer to Figure 2-1. Connect a heavy-gauge braided ground strap or copper wire from the thumb-screw terminal on the rear of the console to a convenient point on the machine base. Check that the ground wire is a minimum length and routed so that it will not be pulled or rubbed during machine operation. Ground the machine base by connecting it to a cold-water pipe or other solid earth ground. A metal stake driven several feet into the ground will suffice if no other ground is available. (No special ground is required for scale assemblies.)
- Plug the console power cord into a properly grounded outlet of the correct voltage.
- Turn the console on and check the fault indicator at the left of the display lights. If the fault indicator does not light, check the line voltage connection to be sure there is power to the outlet.

If the fault indicator still will not light, refer to System Troubleshooting in Section 5.

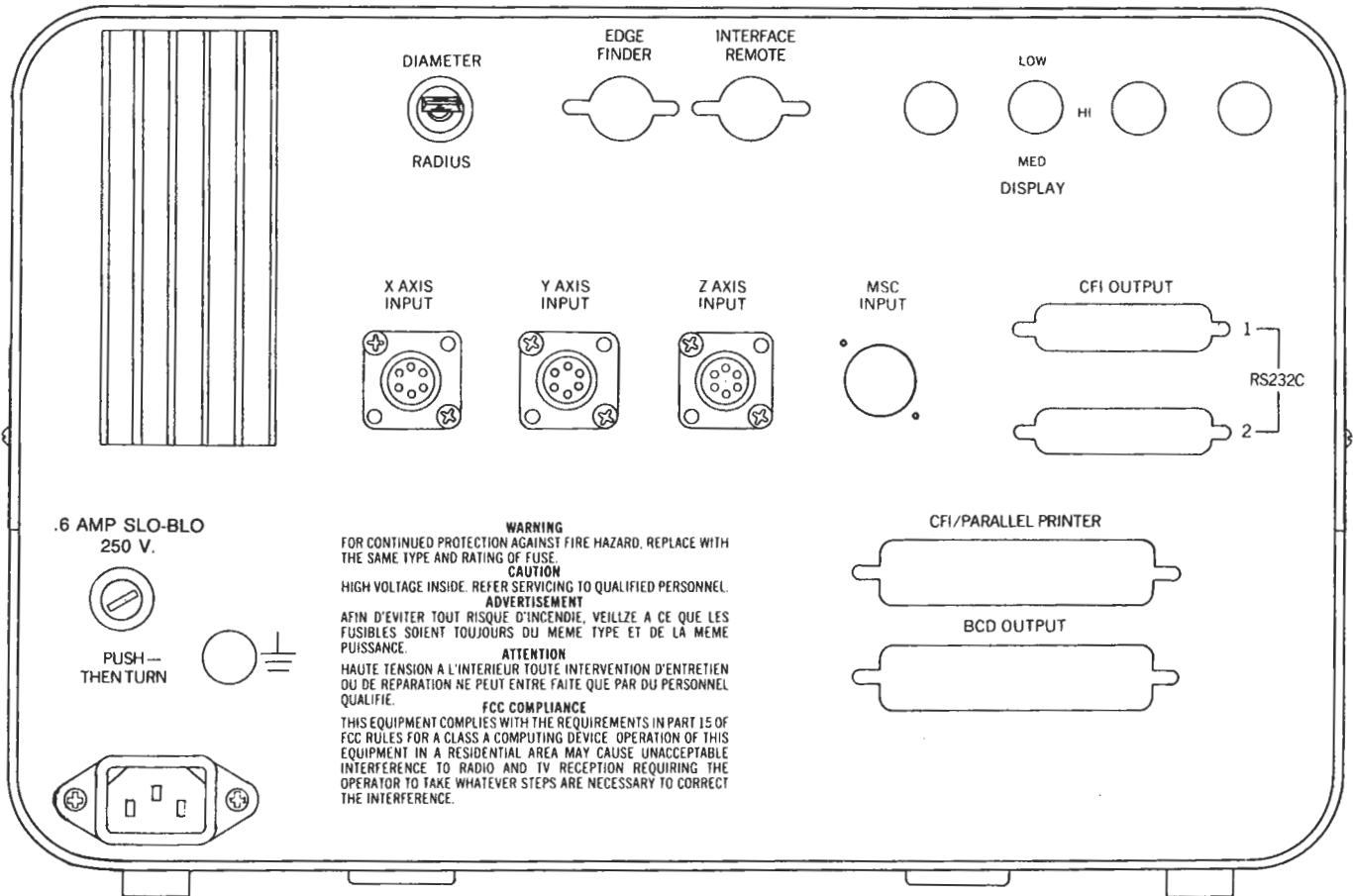

Figure 2-1. Console Electrical Connections

Y — 2 AXIS — X
 X = 1 AXIS

S3 Z
 BOTTOM
 DISPLAY AXIS
 DIP SWITCH
 ASSY.

S2 Y
 MIDDLE
 DISPLAY AXIS
 DIP SWITCH
 ASSY.

S1 X
 TOP
 DISPLAY AXIS
 DIP SWITCH
 ASSY.

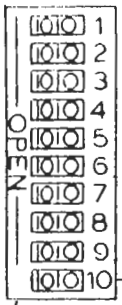
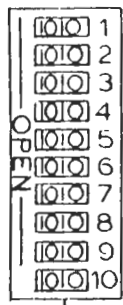
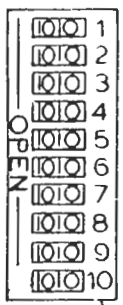

ROCKERS 1-6 ERROR COMPENSATION

ROCKERS 7-9 SCALE RESOLUTION

ROCKER 10 RADIUS/DIAMETER SELECTION

ALL SWITCHES
 SHOWN ARE IN
 CLOSED (ON)
 POSITION

E8
 INCH/mm
 JUMPER

J2 TOP DISPLAY

J3 MIDDLE DISPLAY

J4 BOTTOM DISPLAY

SCALE INTERCONNECT
 CABLE HEADERS
 (FEMALE CONNECTOR
 NOT SHOWN FOR
 CLARITY)

DISPLAY DECIMAL POINT SWITCHES

S6 BOTTOM DISPLAY

S5 MIDDLE DISPLAY

S4 TOP DISPLAY

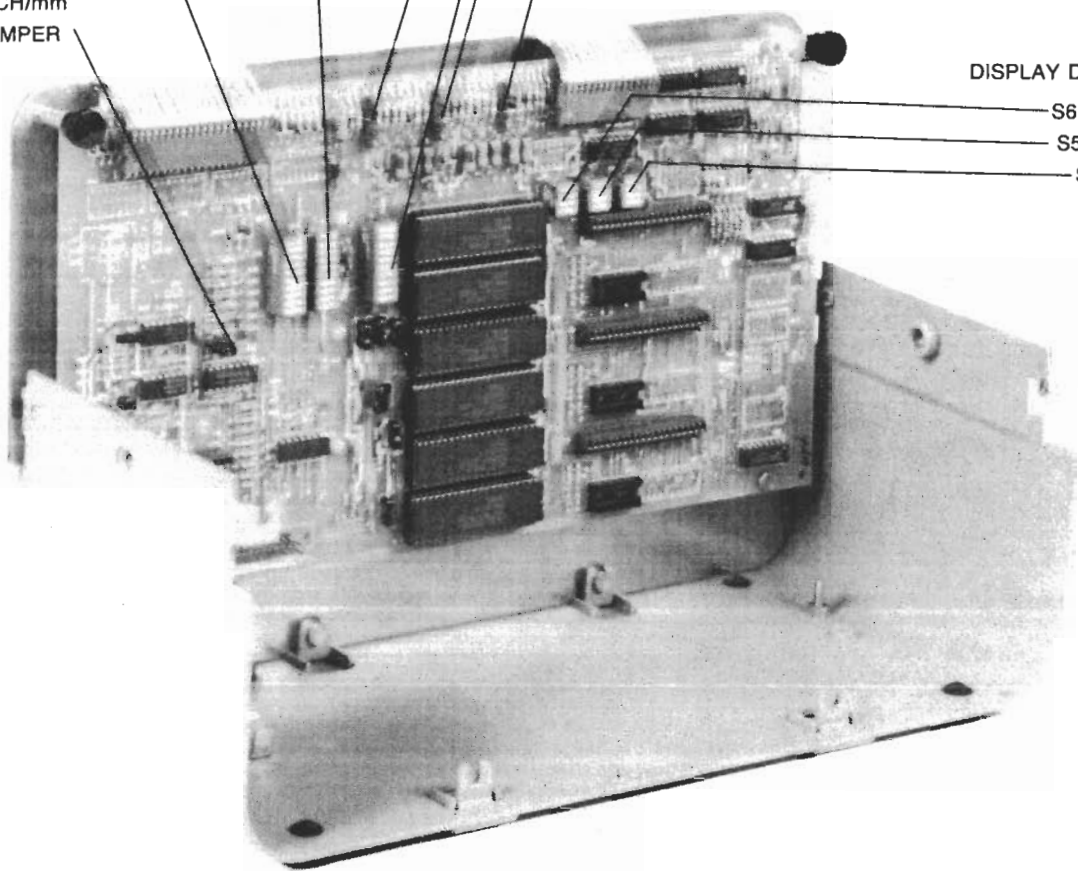

Figure 2-2. Internal Switch and Jumper Locations on Axis Board

2.2.1 Internal Switch Settings

The ACU-RITE III counter requires internal switch settings to set the following counter features:

- 1) scale resolution
- 2) display decimal point location (dependent on scale resolution)
- 3) Radius/Diameter feature for each selected axis
- 4) measurement units (INCH or mm) displayed when counter is first powered-up

These features are established by setting switches and a jumper within the counter chassis. Follow the steps listed below to set-up the counter prior to its use.

The counter is shipped from the ACU-RITE factory with each axis set for a $10\mu\text{m}$ (.0005") scale resolution, no error compensation, and no axes set up for the Radius/Diameter feature. ACU-RITE advises that all switch settings be double checked even if the system being set up is of the same configuration as the factory settings.

NOTE

All work inside of the chassis must be done with the power off and the power cord unplugged. This is for both the protection of the operator and the protection of the electronic circuits.

Switch Settings For Scale Resolution

In order for the counter to recognize the correct scale resolution for each axis the DIP switch assemblies S1, S2, and S3 (see Figure 2-2) must be set according to table 2-1. Note that each axis is associated with one DIP switch assembly; the top axis is set on switch S1, the middle axis, if one is present, is set on S2, and the bottom axis, if it exists, is set on switch S3. Rocker switches 7, 8 and 9 are the specific switches within each switch assembly which are

set to establish the scale resolution for each individual axis. Set these rockers per the information in table 2-1 and then double check the rocker settings.

Switch Settings For Display Decimal Point Location

The decimal point location must be set to display the proper scale resolution. This is controlled by switches S4, S5, and S6 (see Figure 2-3). Switch S4 is for the top axis display, S5 is for the middle axis display, and S6 is for the bottom axis display. Set each individual rocker in accordance with table 2-1.

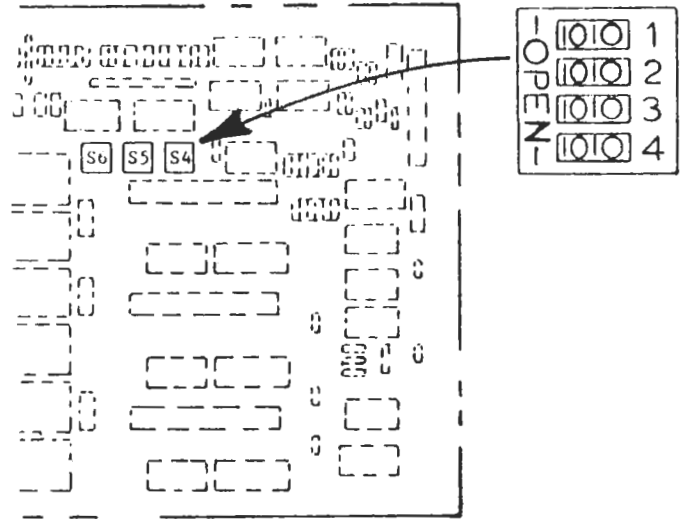

Figure 2-3. Decimal Point Locating Switches on Axis Board Viewed from Back of Counter.

Table 2-1. Internal Switch Settings

Scale Resolution	S1, S2, & S3 Rocker Settings									S4, S5, & S6 Rocker Settings			
	1	2	3	4	5	6	7	8	9	1	2	3	4
.0005"	See						OFF	OFF	OFF	OFF	ON	OFF	ON
.0001"	Error						ON	OFF	OFF	OFF	ON	ON	OFF
$10\mu\text{m}$ (.0005")	Correction						ON	OFF	ON	OFF	ON	OFF	ON
$1\mu\text{m}$ (.00005")	in						ON	ON	ON	ON	OFF	ON	OFF
$2\mu\text{m}$ (.0001")	Section 4						OFF	ON	ON	OFF	ON	ON	OFF
$5\mu\text{m}$ (.0002")							OFF	OFF	ON	OFF	ON	ON	OFF
Switch Settings for Rack & Pinion Rotary Encoder													
$10\mu\text{m}$ (.0005")							ON	OFF	ON	OFF	ON	OFF	ON
$2\mu\text{m}$ (.0001")							OFF	ON	ON	OFF	ON	ON	OFF
.0005"							OFF	OFF	OFF	OFF	ON	OFF	ON
The following scales can be used in a diameter readout mode and still retain the error compensation feature. Note that the readout will display 2x the scale movement (i.e. 1 scale interval will be displayed as 2 scale intervals giving a diameter reading on turned pieces), typical application would be a cross slide on a lathe (see Section 2.2.2). Switch settings are as follows:													
.00025" (Old Style English)							OFF	OFF	OFF	OFF	ON	OFF	ON
$5\mu\text{m}$ (.00025")							ON	OFF	ON	OFF	ON	OFF	ON
$1\mu\text{m}$ (.00005")							OFF	ON	ON	OFF	ON	ON	OFF

Table 2-2. Round-off in mm/inch Conversion

Scale Resolution	Rounded Conversion Increment	
	Direct Conversion (inch)	With Diameter Readout
1µm	.00000", .00005", .00010", .00015", .00020", etc.	.00000", .00010", .00020", .00030", .00040", etc.
2µm	.0000", .0001", .0002", etc.	.0000", .0002", .0004", etc.
5µm	.0000", .0002", .0004", etc.	.0000", .0004", .0008", etc.
10µm	.0000", .0005", .0010", .0015", .0020", etc.	.0000", .0010", .0020", .0030", .0040", etc.

Switch Settings for the Radius/Diameter Feature

For axes which are required to read in a diameter mode, as opposed to a radius mode, an internal rocker must be set correctly. Rocker 10 on DIP switch assemblies S1, S2, and S3 must be in the open position on each axis that the Radius/Diameter feature is to be active on (see Section 2.2.2 for further instructions for the Radius/Diameter feature).

Switch Settings for Measurement Units Upon Power-Up

A feature provided by the AR-III counter is selection of the units of measurement displayed at power-up. The display can be either INCH or mm, to suit individual requirements. This feature is set by the position of jumper plug E8 for all ACU-RITE III's except for counters with the RS-232C option (for these counters the power-up state is controlled by initial software programming, see the RS-232C OPERATOR'S MANUAL for instructions). With the jumper on pins 1-2, the counter will power-up in the INCH mode; on pins 2-3, the counter will power-up in the millimeter mode. Note that at any time the display can still be changed from INCH to millimeter or vice versa, the INCH or mm selection is for power-up only.

Switch Settings for Error Compensation

Rockers 1-6 on DIP switch assemblies S1, S2, and S3 are the rockers set to establish error compensation for each axis. Instructions for setting these rockers as well as methods for measuring how much error correction is required are found in Section 4 of this manual.

NOTES

- 1) Some counters have internal switches with slightly different labeling. For these switches "open" corresponds to OFF.
- 2) Display round-off
 - a. When using an English scale in the INCH mode or a metric scale in the mm mode, the least significant display digit (farthest to the right) will indicate multiples of the scale resolution (10µm resolution scales will provide multiples of 1, 2µm resolution scales will provide multiples of 2, etc.). In the diameter readout mode, the least significant display digit will indicate multiples of twice the scale resolution (e.g., 10µm resolution scales provide multiples of 2), except for 2µm resolution scales, which will be rounded to multiples of 5.
 - b. With an English scale used in the mm mode, the ACU-RITE III system performs exact multiplication (25.4mm/inch) rounded to the nearest least significant digit.

- c. With a metric scale used in the INCH mode, displayed numbers will be rounded for operator convenience. In this case, the rounding will apply both to direct conversion and conversion with Diameter Readout selected (as shown in Table 2-2).

2.2.2 SWITCHABLE RADIUS/DIAMETER FEATURE

In certain machining operations, such as movement on the cross-feed of a lathe, a doubling of the measured dimensions is often desired for diameter display. The ability to switch a specific display axis between a radius display to a diameter display is conveniently provided by a simple switch on the back of the ACU-RITE III counter.

Before this switch is active, there are internal switches within the counter which must be set (this safeguards against accidental actuation). The switch settings for the Radius/Diameter feature are described in section 2.2.1 above. In addition to the switch setting of rocker 10 on each axis, it is also necessary to set rockers 1-5 to ON and rocker 6 to OFF for each DIP switch assembly (S1, S2, and S3) for which the Radius/Diameter feature is desired. Note that this means that the axis which is to be switchable from radius display to diameter display, can not have error compensation, since rockers 1-6 normally control this function.

Once the internal rockers are set the display can be toggled between a radius and diameter mode by switching the RADIUS/DIAMETER switch on the back of the counter. Note that this switch will not convert an existing value but that it only electronically doubles the incoming scale movement information before it is displayed.

At the bottom of table 2-1 there are scales listed which can be used in the diameter mode and still retain their error compensation capabilities. Upon studying the rocker settings it will be evident that what is done is to use a scale of one resolution but set the counter up as if it was a scale of twice the resolution (e.g. 5µm scale and 10µm rocker settings). This configuration gives the axis a diameter reading on a radius cut. There is a trade-off for this method of establishing a diameter display. Although axis error compensation is now available (rockers 1-6 set the axis error compensation) the axis is set in a permanent diameter mode. The axis cannot be switched back and forth, with the Radius/Diameter switch on the back of the counter, when using this method for a diameter display.

2.2.3 DIRECTIONAL POLARITY

Machine tool travel polarity can be reversed by disconnecting the reading head input cable connector from the axis board (J2, J3, or J4 depending on which axis needs reversing), rotating the white connector 180° and reconnecting it to the axis board (see Fig. 2-2).

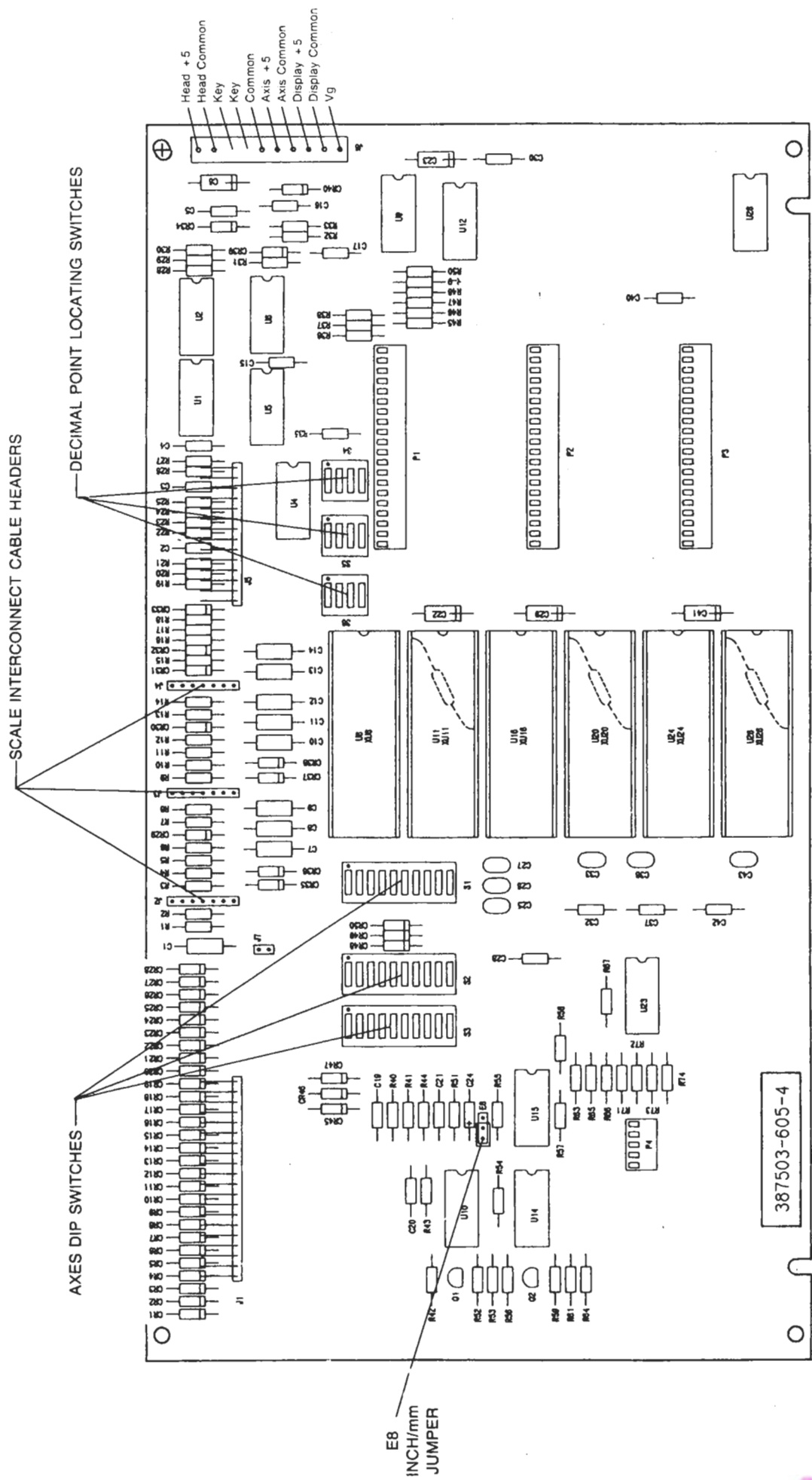

Figure 2-4. Triple Axis Board

SECTION 3 OPERATION

3.1 GENERAL

Operating your machine tool will be much easier with a digital measuring system once you see what you can do with the system—and what it can do for you. As you move your machine table a chosen distance, the system tracks the movement and displays it on the DRO console, clearly showing when the table has traveled the exact distance. You and your machine are in constant communication so that table position is always known, within the resolution you're working to, down to $1\mu\text{m}$ (.00005") depending on your system's resolution.

This section contains all of the descriptions and procedures you'll need to operate the ACU-RITE III system. Control Panel Description, paragraph 3.2, identifies the operating features on the front of the console, what each control does, and how to include tool offset in the measurement; Operating Procedures, paragraph 3.3., is a step-by-step instruction of how to operate the DRO as part of the machining process and provides examples to demonstrate how you, your machine, and the system work together.

NOTE

A soil-resistant, laminated operator's card is provided with this manual to be attached to your machine tool. After thoroughly reading and understanding this section, use the card for convenience.

3.2 CONTROL PANEL DESCRIPTION

Control panel features are shown in Figure 3-1.

3.2.1 Fault Indicator

When you turn the console on, the display shows a fault indicator at the left of each axis window (otherwise blank). This vertical mark will not appear during normal system operation; but if it lights during operation (and the display blanks), you'll know that shop or system power has been momentarily interrupted, the table has been moved too fast (excessive slew rate), or that the scale or counter is malfunctioning. This indication guards against false measurements on the display that may go unnoticed. In any case, you'll have to restart your operational procedures.

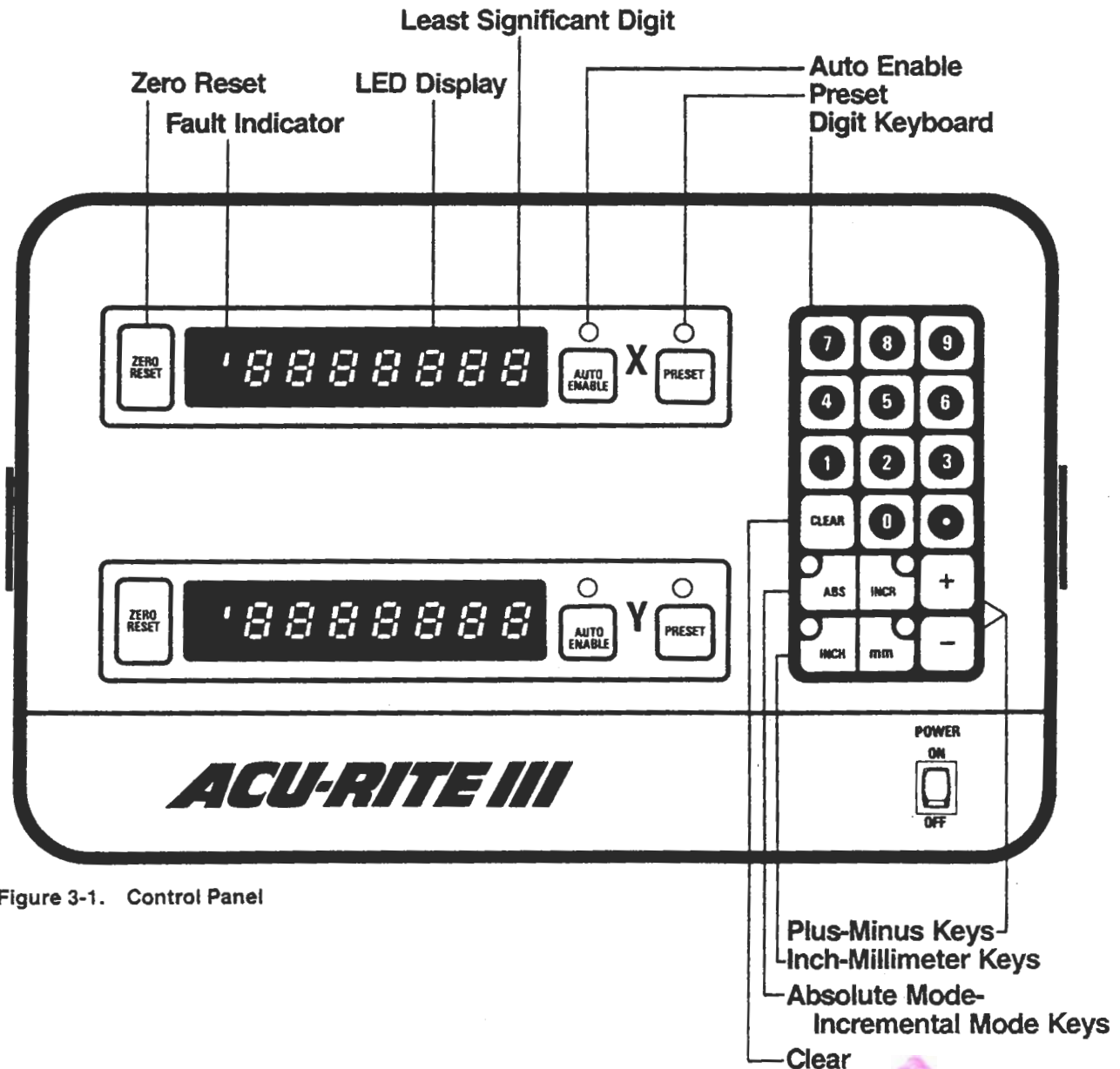

Figure 3-1. Control Panel

3.2.2 L.E.D. Display

- Shows measured absolute distance when in the absolute mode (ABS key lit and PRESET key not lit).
- Shows measured incremental position when in the incremental mode (INCR key lit and PRESET key not lit).
- Shows value entered in preset memory when in the incremental or absolute mode and PRESET key is pushed (PRESET key is lit).
- When in either the incremental or the absolute mode, the plus or minus sign at the left of the display indicates the direction from the zero reference point (polarity of table travel). However, when the value in the preset memory is being displayed, it is always an absolute number (no sign), and the plus or minus sign tells you whether you last added or subtracted that value.

3.2.3 ZERO RESET Key

Pushing the ZERO RESET key in each axis resets the counters to zero in either the absolute mode or the incremental mode. The display shows all zeros, unless the preset value is displayed (PRESET key lit). In that case, the incremental mode is still zeroed, but the preset value continues to be displayed.

3.2.4 AUTO ENABLE Key (Useable only with optional Absolute Zero Scales)

The auto enable feature is activated by pushing AUTO ENABLE for the desired axis.

Marks are placed on the scale at 8-inch (200mm) intervals, the first one being anywhere from 0" to 8" from the end of the scale (depending on mark location when the glass scale is cut). When the reading head senses this mark, a fiducial trigger output (FTO) pulse is produced that causes the console to zero and display all zeros on the specific axis. These FTO marks are sensed when the AUTO ENABLE key on the front of the console is lit. Otherwise, the system ignores the FTO mark as you move past it. The reading head includes a separate LED and photo-transistor for sensing the FTO mark, and the display will indicate when the reading head passes over the mark from either direction.

NOTE

If the console is measuring in incremental mode, zero will be displayed only in incremental mode. The absolute mode will retain the total distance traveled. The opposite is true if the console starts out in the absolute mode.

A console with the auto enable can be used with scales having no FTO marks.

Normal measurements will take place, but the auto enable feature will not be usable.

3.2.5 PRESET Key

There are two preset memories: one for absolute mode and one for incremental mode. The memory displayed depends on the mode the counter was in when the preset feature was activated. Selection of this feature:

- Changes the display from the incremental or absolute measurement to the value in the memory.
- Activates the preset keyboard functions (CLEAR, digit, and plus and minus keys).
- Measures machine table coordinates in either measurement mode, but only the preset value is displayed.
- Returns operator to incremental or absolute mode (whichever was selected last) when not adding or subtracting the preset value.
- Will be automatically cancelled after adding or subtracting a preset value into the mode displayed.

3.2.6 Digit Keyboard

Used to enter a new value into preset memory when the PRESET key is lit and the CLEAR key has been pushed. Leading and trailing zeros do not have to be entered; e.g., for 0.2300, enter: decimal point, 2, and 3.

3.2.7 CLEAR Key

Functional only when the PRESET key is lit.

- Clears the value in the incremental or absolute preset memory. (The display will blank).
- Enables entry of new value into preset memory.

3.2.8 ABS-INCR Keys

When lit, ABS key switches the display from the incremental mode value to the absolute mode, and displays the absolute measurement (total movement of the table from zero measured in any one axis).

When INCR is lit, incremental mode is active for point-to-point measuring.

3.2.9 INCH-mm Keys

Instantly converts incremental or absolute mode measurement from inches to millimeters, and vice versa. Does not convert value in preset memory even though decimal place will change.

3.2.10 Plus-Minus Keys

Keys are functional only when the PRESET key is lit. These keys may be used following a digit keyboard entry or immediately after pushing the PRESET key if reusing an established preset value.

- When used to enter preset, PRESET light goes out when either key is pushed indicating that the plus or minus preset value has been entered into the preset memory. The display will then be returned to the incremental or absolute mode and will display the new measurement (equal to the measurement, plus or minus the value entered in the preset memory).
- When used for tool radius/diameter offset, adds or subtracts the radius/diameter dimension (plus or minus) from the measurement.

3.2.11 Including Tool Offset Dimensions

Use the digit keys and the plus and minus keys to add or subtract a dimension from the incremental measurement displayed at any time.

Before the tool offset function can be used effectively, the polarity of the machine tool table travel must be established. Refer to the system checkout procedure in the separate installation instructions.

Machine tool table travel polarities are illustrated for a typical milling machine in Figure 3-3.

3.3 OPERATING PROCEDURES

The following is a series of procedures for setup and operation of the system for machining. Examples are provided for each procedure to demonstrate the use of the DRO in practice. Most examples show the X-axis only, but apply to the Y- or Z-axis as well.

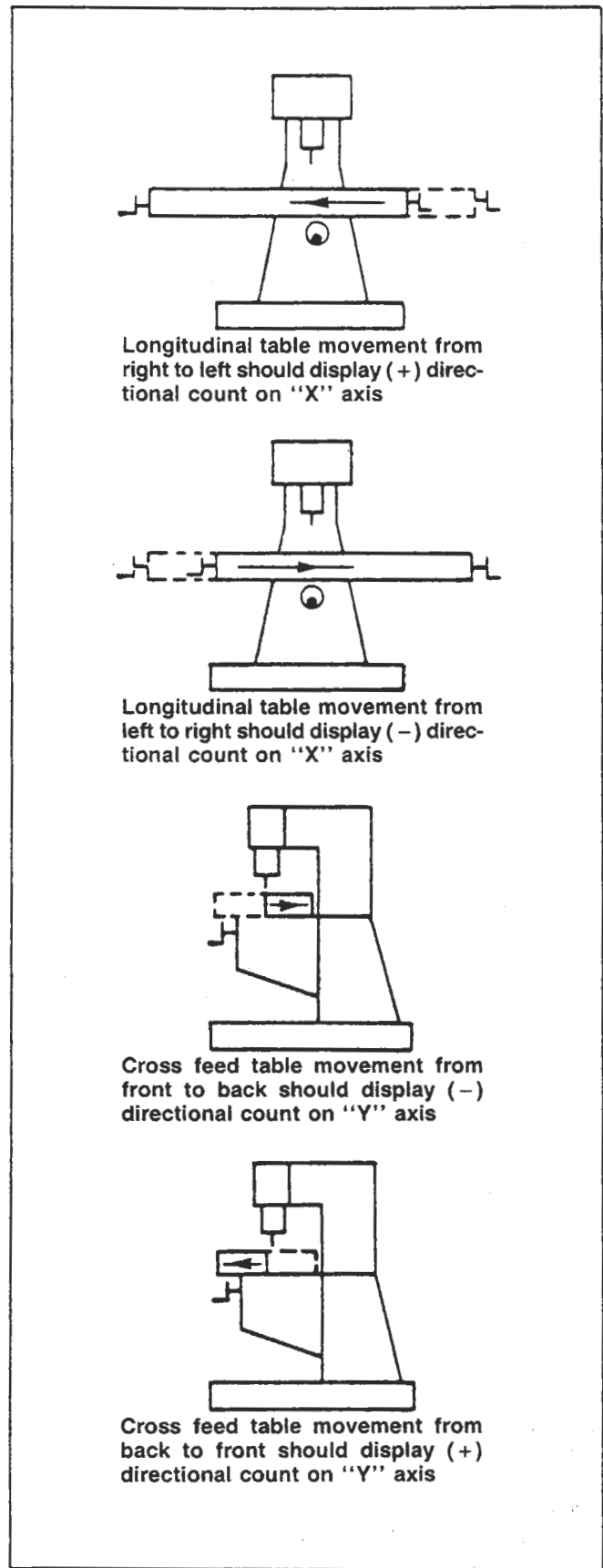

Figure 3-3. Table Travel Polarities (Direction).

3.3.1 Setup

- Place the workpiece in position and move the table to the location of your zero coordinates (starting point).
- Flip the console POWER switch to ON (see Figure 3-4). The ABS and INCH keys and fault indicator(s) at the left of the display(s) will light and the display(s) will be blank, indicating that the fault circuits are working properly in the absolute mode.

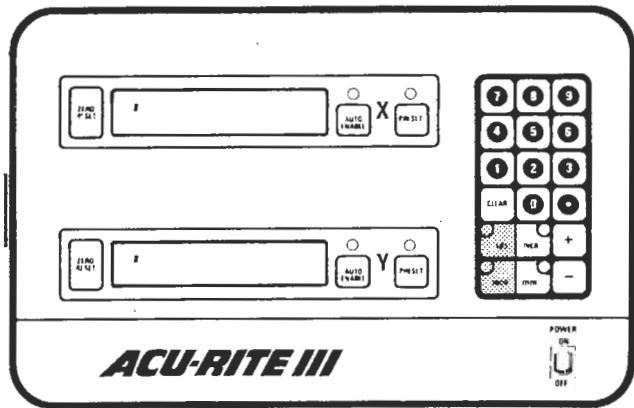

Figure 3-4. Console Status: Power On

- Push the ZERO RESET keys for each axis to zero the absolute mode. Plus sign and zeros will be displayed (see Figure 3-5).

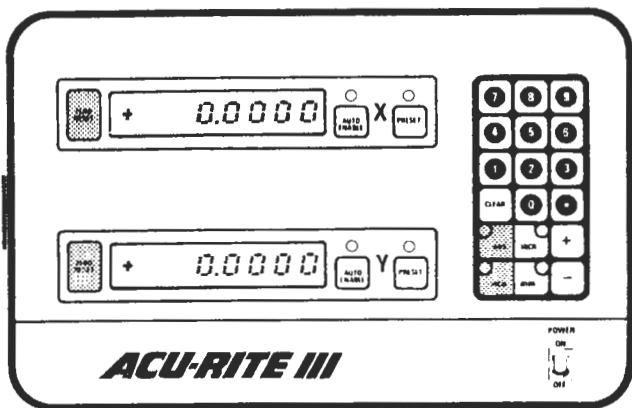

Figure 3-5. Console Status: Zero Reset

- Push the INCR key (see Figure 3-6). The incremental key will light, changing the console to the incremental mode. The fault indicator(s) will light again, indicating that the fault circuits are working properly in the incremental mode.
- Push the ZERO RESET keys for each axis again to zero the incremental mode, and plus zeros will be displayed (see Figure 3-5).
- Make proper selection if INCH or mm switch to be certain that measurements will be made and displayed in the correct dimensions (inches or millimeters). The appropriate key will light.

NOTE

The display will read 0.00000 or 0.0000 in INCH measurement or either 0.00 or 0.000 in mm measurement, depending on the resolution of the system.

YOUR ACU-RITE III SYSTEM IS NOW READY TO USE.

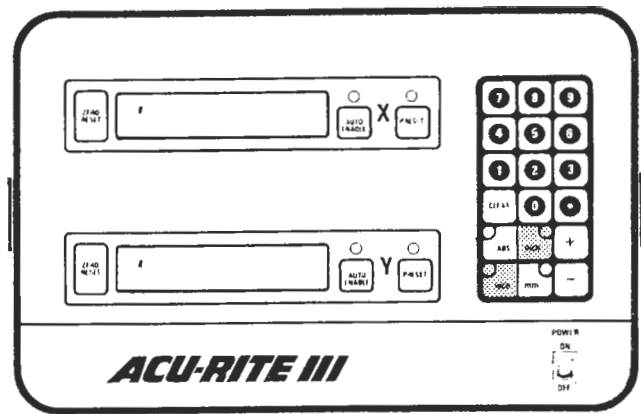

Figure 3-6. Console Status: Fault Indicator

3.3.2 Incremental Mode Operation

When you use the ACU-RITE digital measuring system, normal operation of your machine tool (for simple jobs like drilling a few holes or slot-milling) is done in the incremental mode. In other words, the system is measuring and displaying the table travel incrementally, or point-to-point (hole-to-hole, start-to-finish, etc.). Figure 3-7 represents an example of a job to be machined in the incremental mode; that is, to locate and drill holes A, B and C. Here is the procedure for system operation using the ZERO RESET key to re-zero the X-axis display at the start of each point-to-point dimension:

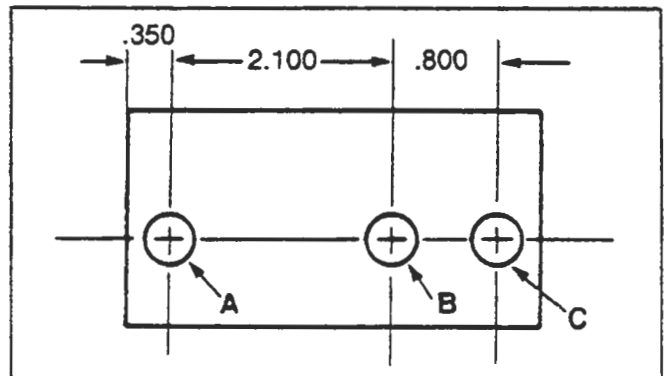

Figure 3-7. Workpiece for Incremental Procedure

- Locate and drill hole A.
- Push the ZERO RESET key on the X-axis.
- Move the table to the left until the display reads +2.1000, and drill hole B.
- Push the ZERO RESET key again.
- Move the table to the left until display reads +0.800, and drill hole C.

3.3.3 Preset Operation

The preset function permits you to enter the coordinate dimension into the memory as well as to display it. Therefore, as the table is moved the display changes incrementally from the dimension to zero, just opposite of normal incremental operation. To preset the incremental mode with a specific dimension, proceed as follows:

- Push the INCR key to put console in incremental mode.
- Push the ZERO RESET key on the desired axis to zero the incremental mode display.

- c. Push the PRESET key on the desired axis (see Figure 3-8). The key will light up, and the display will indicate the value in the preset memory (zero or any previously entered number).

- f. To preset the incremental mode to the above value, push the plus or minus key, depending on whether the preset value is to be positive or negative (see Figure 3-11). The PRESET light will go out and the display will now indicate the preset machine coordinates.

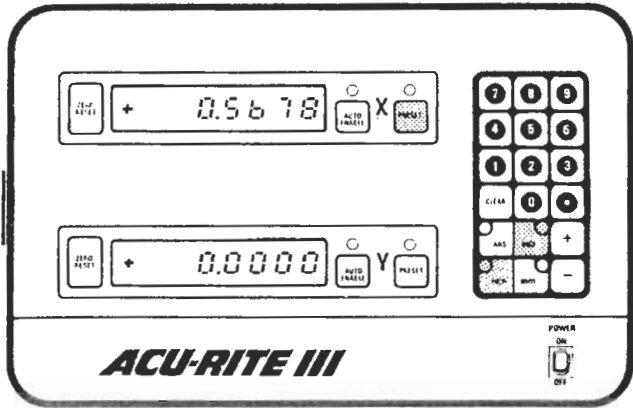

Figure 3-8. Console Status: Preset Value Display

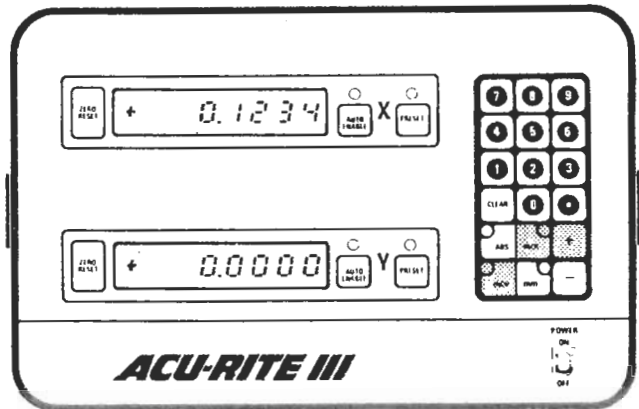

Figure 3-11. Console Status: Preset Entry, Incremental Mode

NOTE

When the PRESET key is lit, the system will still measure the machine coordinates, but not display them.

- d. Push the CLEAR key to clear any previous number from the preset memory. The display will blank out except for the decimal point (see Figure 3-9).

NOTE

The preset value may be recalled at any time by simply pushing (lighting) the PRESET key. To return to the incremental mode, push the PRESET key again (light out).

3.3.3.1 EXAMPLE PROCEDURE A

Figure 3-12 represents the same job as the one done under Incremental Mode Operation, paragraph 3.3.2., (locate and drill holes A, B and C), except that the following procedure uses the preset function rather than re-zeroing for each point-to-point dimension.

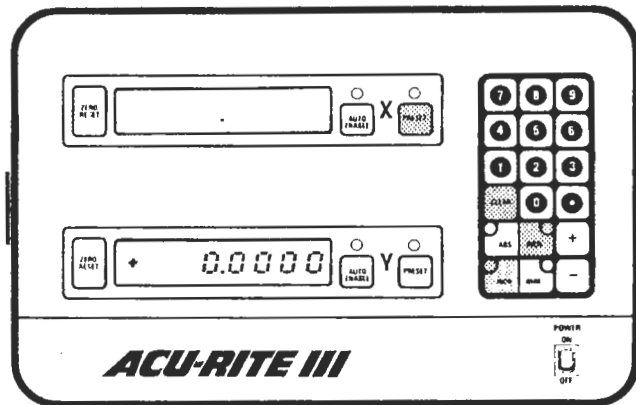

Figure 3-9. Console Status: Clearing Preset and Display

- e. Enter the preset value by pushing the appropriate digit keys, including the decimal point (see Figure 3-10). If an error is made, push the CLEAR key and start again.

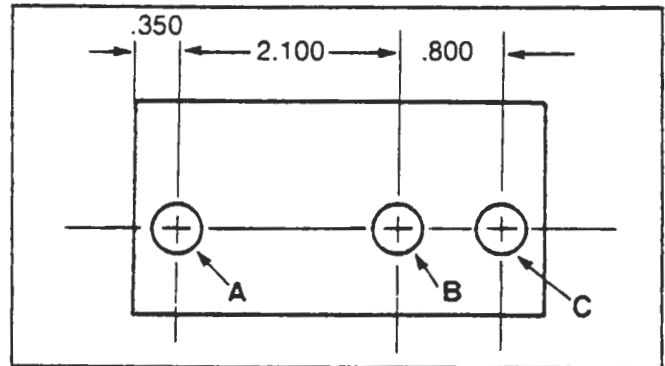

Figure 3-12. Workpiece for Preset Procedure A

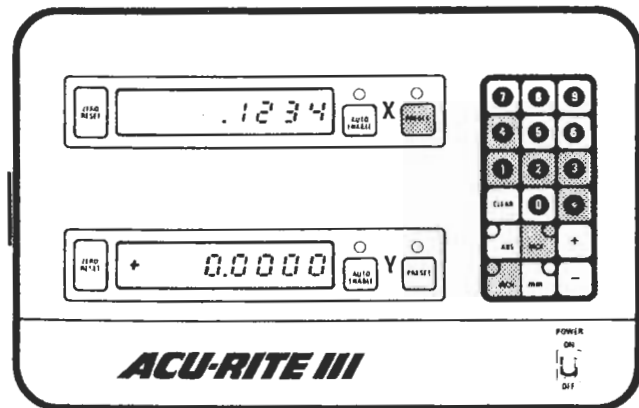

Figure 3-10. Console Status: Digit Display

- Locate and drill hole A.
- Push the ZERO RESET key on the X-axis.
- Push the PRESET key on the X-axis.
- Push the CLEAR key (display will blank).
- Push the digit keys for the value being entered onto the preset memory: 2, decimal point, and 1.
- Push the minus key. The display will read -2.1000 and the PRESET light will go out.
- Move the table to the left until the display reads $+0.0000$, and drill hole B.
- Push the PRESET key again.
- Push the CLEAR key (display will blank).
- Push the digit keys for the new preset value: decimal point and 8.

- k. Push the minus key. The display will read -0.8000 , and the PRESET light will go out.
- l. Move the table to the left until the display reads $+0.0000$, and drill hole C.

NOTE

When presetting, the plus and minus keys will represent the current reference surface from which you move the tool toward the next operation. For the:

X-axis, use the plus key if next hole location is to the left.

Y-axis, use the plus key if next hole location is toward the operator.

X-axis, use the minus key if next hole location is to the right.

Y-axis, use the minus key if next hole location is away from operator.

3.3.3.2 EXAMPLE PROCEDURE B

Figure 3-13 represents another example of machining operation, this time using the preset function for drilling a series of equally-spaced holes, A, B, C and D. The procedure is as follows:

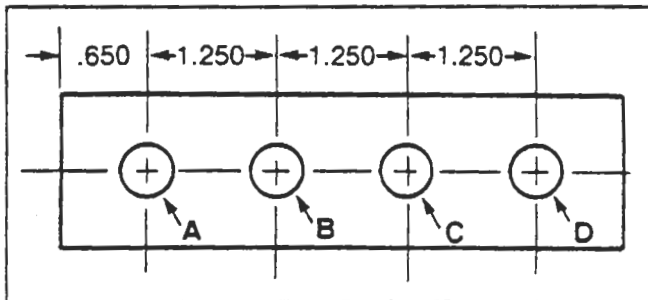

Figure 3-13. Workpiece for Preset Procedure B

- a. Locate and drill hole A.
- b. Push the ZERO RESET key on the X-axis.
- c. Push the PRESET key (it will light) on the X-axis.
- d. Push the CLEAR key (display will blank).
- e. Push the digit keys for the value being entered into the preset memory: 1, decimal point, 2, 5.
- f. Push the minus key. The display will read -1.2500 and the PRESET LED will go out.
- g. Move the table to the left until the display reads $+0.0000$, and drill hole B.
- h. Push the PRESET key (it will light) on the X-axis. The display will show the value in the preset memory to be -1.2500 .
- i. Push the minus key to display the preset value (-1.2500) in the incremental mode.
- j. Move the table to the left until the display reads $+0.0000$, and drill hole C.
- k. Push the PRESET key again on the X-axis.
- l. Push the minus key. The display will read -1.2500 .
- m. Move the table to the left until the display reads $+0.0000$, and drill hole C.

3.3.4 Tool Offset Operation

As stated previously under Including Tool Offset Dimensions, paragraph 3.2.11, you can machine a workpiece using the offset by simply adding the tool diameter or radius to (or subtracting it from) the value shown on the display. There are no pencil calculations needed for this technique. The following procedures, A through D, are four examples (two for diameter, two for radius) that will give you a good working knowledge of how to use the preset function of the system for tool offset operation. Understand that in each procedure, setup has already been done (see Setup, paragraph 3.3.1, earlier in this section).

3.3.4.1 EXAMPLE PROCEDURE A

The workpiece (see Figure 3-14) is to be machined on surfaces A and B with a .250-inch diameter tool, using surface C as a reference. Offset will be the tool diameter, and table movement will be in the X-axis. Here is the procedure:

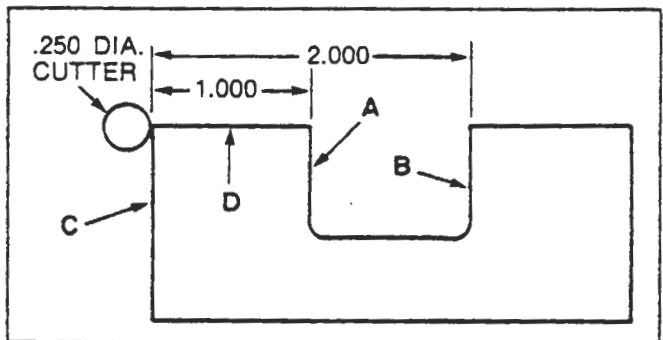

Figure 3-14. Workpiece for Tool Offset Procedure A

- a. Locate the tool against surface C.
- b. Push the ZERO RESET key on the X-axis.
- c. Push the PRESET key (it will light) on the X-axis.
- d. Push the CLEAR KEY.
- e. Push the digit keys for tool diameter: decimal point, 2 and 5.
- f. Push the minus key to:
 1. Enter the tool diameter into the preset memory.
 2. Shift the datum line (reference) from surface C to the left of the tool.
 3. Display the tool diameter (0.2500) in the incremental mode.
- g. Move the table to the left, with the tool parallel to but not touching surface D, until the display reads $+1.0000$, and machine surface A.
- h. Push the PRESET key (it will light) on the X-axis. The display reads -0.2500 in the preset memory.
- i. Push the plus key to:
 1. Shift the datum line (reference) back to the right face of the tool.
 2. Display $+1.2500$ in the incremental mode.
- j. Move the table to the left until the display reads $+2.0000$, and machine surface B.

3.3.4.2 EXAMPLE PROCEDURE B

The workpiece (see Figure 3-15) is to be machined on surfaces A and B with a .250-inch diameter tool, using surface D as a reference. Offset will be the tool diameter, and table movement will be in the Y-axis. Here is the procedure:

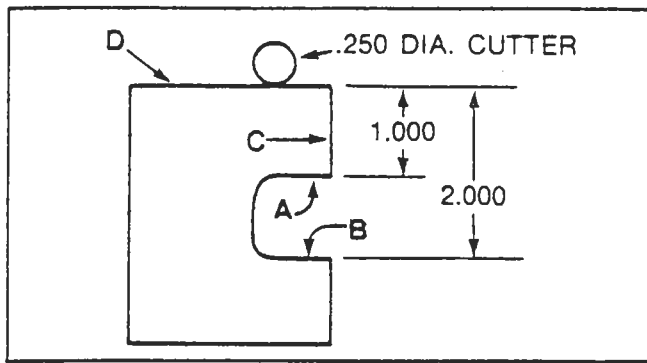

Figure 3-15. Workpiece for Tool Offset Procedure B

- a. Locate the tool against surface D.
- b. Push the ZERO RESET key on the Y-axis.
- c. Push the PRESET key (it will light) on the Y-axis.
- d. Push the CLEAR key.
- e. Push the digit keys for the tool diameter: decimal point, 2 and 5.
- f. Push the plus key to:
 1. Enter the tool diameter into the preset memory.
 2. Shift the datum line (reference) from surface D to the back surface of the tool.
 3. Display tool diameter (+0.2500) in the incremental mode.
- g. Move the table to the rear (away from you) with the tool parallel to but not touching surface C, until the display reads -1.0000. Machine surface A.
- h. Push the PRESET key (it will light) on the Y-axis. The display reads +0.2500 in the preset memory.
- i. Push the minus key to:
 1. Shift the datum line (reference) to the front surface of the tool.
 2. Display -1.2500 in the incremental mode.
- j. Move the table to read until the display reads -2.0000, and machine surface B.

3.3.4.3 EXAMPLE PROCEDURE C

The workpiece (see Figure 3-16) is to be machined on surface A with a .500-inch diameter tool, and drilled for hole B. Offset will be the tool radius, and table movement will be in the X-axis. (Though Y-axis movement would normally take place, it is omitted for simplicity.) Here is the procedure:

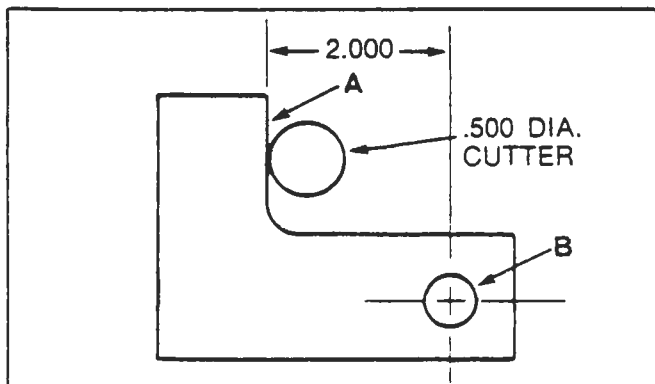

Figure 3-16. Workpiece for Tool Offset Procedure C

- a. Machine surface A with the tool positioned as shown.
- b. Push the ZERO RESET key on the X-axis.
- c. Push the PRESET key (it will light) on the X-axis.
- d. Push the CLEAR key.
- e. Push the digit keys for the tool radius: decimal point, 2, 5, and 0.
- f. Push the plus key to:
 1. Enter the tool radius into the preset memory.
 2. Shift the datum line (reference) to the right and to the centerline of the tool.
 3. Display the tool radius (+0.2500) in the incremental mode.
- g. Move the table to the left until the display reads +2.0000. Insert the correct drill and drill hole B.

3.3.4.4 EXAMPLE PROCEDURE D

The workpiece (see Figure 3-17) is to have holes A and B drilled, using a .200 diameter edge finder for workpiece referencing. Offset will be the radius of the edge finder, and table movement will be in the X-axis. Here is the procedure:

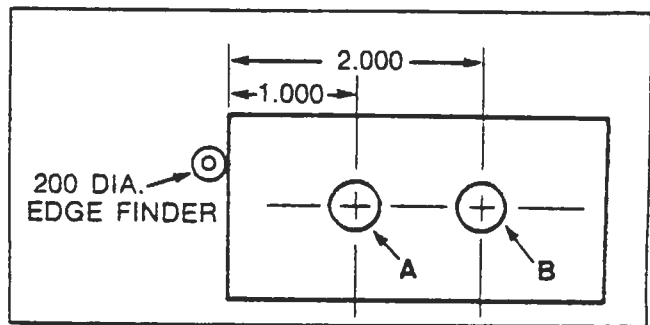

Figure 3-17. Workpiece for Tool Offset Procedure D

- a. Put the edge finder against the left face of the workpiece.
- b. Push the ZERO RESET key on the X-axis.
- c. Push the RESET key (it will light) on the X-axis.
- d. Push the CLEAR key.
- e. Push the digit keys for the edge finder radius: decimal point, 1.
- f. Push the minus key to:
 1. Enter the edge finder radius into the preset memory.
 2. Shift the datum line (reference) to the left, i.e., to the centerline of the edge finder.
 3. Display the radius (-0.1000) in the incremental mode.
- g. Move the table to the left until the display reads +1.0000, and drill hole A.
- h. Move the table to the left until the display reads +2.0000, and drill hole B.

3.3.5 Absolute Mode Operation

In this manual, the term "absolute" (used with "mode" or "measurement") refers to the distance from present table position in a specific axis to the original (starting) zero reference point. The absolute measurement is, therefore, normally the total of the incremental measurements in a given axis. However, both the absolute mode and the incremental mode can be combined and used to machine (see Combined-Mode Operation, paragraph 3.3.6).

NOTE

ABS and INCR are preset one at a time. Switching from one to the other disables the preset in the non-display register.

You should be familiar with the following additional points on the use of the absolute mode:

- a. When the console is turned on, the ABS (absolute) key lights. Also, the fault indicator lights in the display (otherwise blank) indicating that the fault circuitry is working properly in the absolute mode. Push the ZERO RESET key on each axis display to zero the absolute mode; then push the INCR key (key will light) to select the incremental mode (see Incremental Mode Operation, paragraph 3.3.2).
- b. To switch to the absolute mode during an incremental machining operation, push the ABS key to light it (Figure 3-18). The display will instantly change to the measurement in the absolute mode (without losing the incremental measurement).

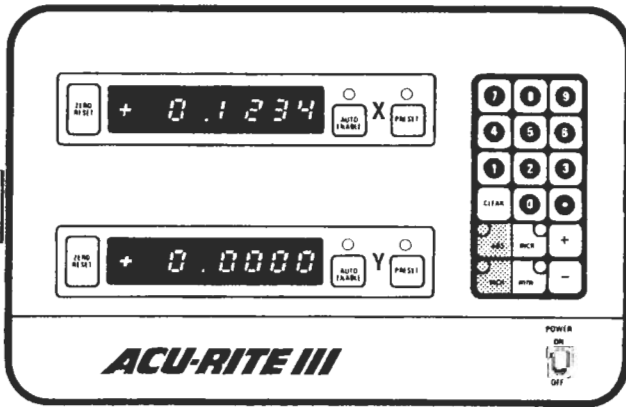

Figure 3-18 Console Status: Absolute Mode

- c. To re-zero the absolute mode when in the incremental mode, push the ABS key (it will light), and push the ZERO RESET key(s); then push the INCR key again (key will light) to return to the incremental mode.
- d. When in the absolute mode, pushing the PRESET key will allow you to preset the absolute register (Figure 3-19).

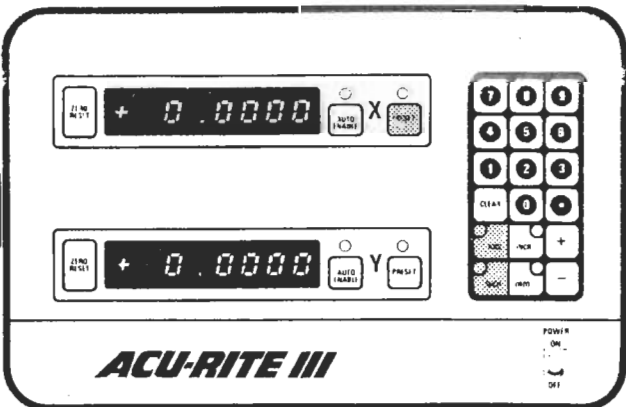

Figure 3-19 Console Status: Preset Entry, Absolute Mode

- e. The absolute mode can be used just like the incremental mode (Figures 3-20 and 3-21). As a rule, however, the absolute mode should be used as in step "b" above or for machining in combination with the incremental mode.

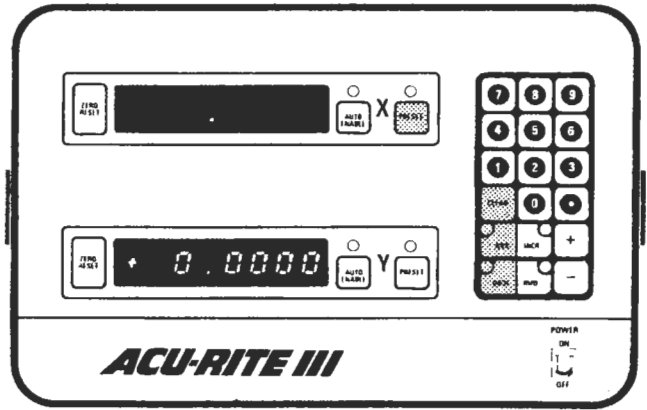

Figure 3-20 Console Status: Clearing Preset in Absolute Mode

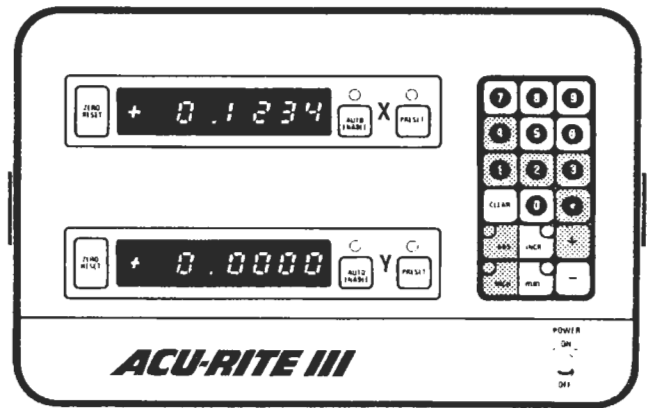

Figure 3-21 Console Status: Digital Display in Absolute Mode

3.3.6 Combined-Mode Operation

When you machine using both incremental and absolute modes, you are operating the system as though it were two separate DROs: one to measure movement between successive cutting locations, and the other to measure the distance a cutting location is from the zero reference location. The part drawing you're working with will determine when to use the combined mode operation; specifically, when at least one machining dimension is referenced to the zero surface of the workpiece, and one or more successive incremental operations precede it, as is the case shown in Figure 3-22. The following is a typical example of a combined-mode procedure.

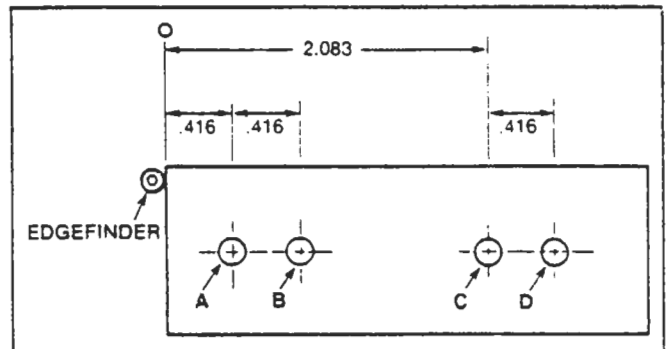

Figure 3-22. Workpiece for Combined Mode Procedure

In this example, the workpiece (see Figure 3-22) is to be drilled at four locations along the X-axis. The zero reference is established at the left surface of the workpiece. Notice that the dimension for hole C (2.083) is referenced from the zero point. This lets you know that you will be using the absolute mode to drill that hole (the size of the drill is arbitrary for this example). You will be using the radius offset of an edge finder to establish the centerline at the zero reference point. Here is the procedure (perform Setup procedure, paragraph 3.3.1, first):

- a. With the edge finder located against the left surface of the work piece, push the ABS key.
- b. Push the ZERO RESET key on the X-axis to zero the absolute mode.
- c. Push the PRESET key (it will light) on the X-axis.
- d. Push the CLEAR Key.
- e. Push the digit keys for the edge finder radius offset: decimal point, 1.
- f. Push the minus key to:
 1. Enter the offset into the preset memory.
 2. Shift the datum line (reference) from the left surface of the workpiece to the centerline of the edge finder.
- g. Move the X-axis until the absolute display reads zero.
- h. Push the INCR key to change to the incremental mode.
- i. Push the ZERO RESET key on the X-axis to re-zero the incremental mode.
- j. Insert the drill and move the table to the left until the display reads +0.4160, then drill hole A.
- k. Push the ZERO RESET key on the X-axis to re-zero the incremental mode.
- l. Move the table to the left again, until the display reads +0.4160, and drill hole B.
- m. Push the ABS key to change to the absolute mode. The display will read +0.8320.
- n. Move the table to the left until the display reads +2.0830, and drill hole C.
- o. Push the INCR Key to change back to the incremental mode. The display will read 1.6670.
- p. Push the ZERO RESET key on the X-axis to re-zero the incremental mode.
- q. Move the table to the left until the display reads +0.4160, and drill hole D.
- r. Push the ABS Key to change to the absolute mode and check your absolute dimension. The display will read +2.4990.

3.4 HOW TO USE AUTO ENABLE

- a. Push the AUTO ENABLE key for the desired axis. The key will light (Figure 3-23).

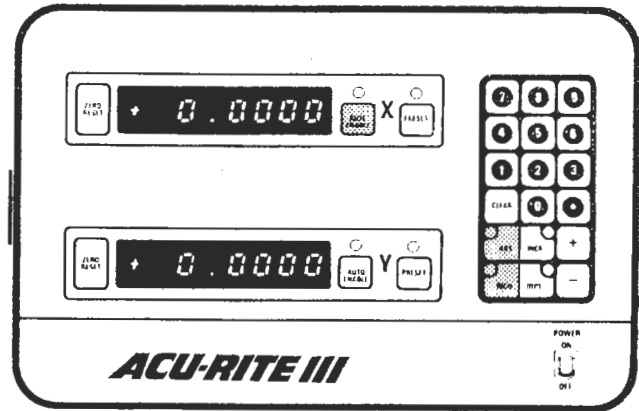

Figure 3-23 Console Status: Auto Enable

- b. Approach the point to be measured in the positive direction (lower number to higher number). The display will automatically reset after passing the FTO mark closest to the point being measured.
- c. When the console resets, AUTO ENABLE is automatically turned off.
- d. Center the tool (endmill, dial indicator, etc.) at the point to be measured. The distance displayed on the console indicates the measured distance between the FTO mark and the point location. For future reference, record the measured distance.
- e. To relocate this point at any time, follow steps "a" through "d" until you come back to your recorded measurement.

SECTION 4 MACHINE TOOL ERROR COMPENSATION

4.1 WHY ERRORS OCCUR

In every machining operation, there is always some degree of error or inaccuracy due to at least one of the following machine tool deficiencies:

- Gravity causes deflections in the machine tool structure (see Figure 4-1), particularly when a heavy workpiece is placed on a machine with overhanging table or ways. A result of these deflections is commonly called Abbé error. (The following paragraphs provide further explanation.)
- The fit between mating surfaces is loose, because of either manufacturing tolerances, subsequent wear, or improper gib adjustment.
- The ways are not scraped straight or are not aligned perfectly at assembly.
- Driving and cutting forces cause deflections, since no material is totally rigid.
- Temperature gradients can distort machine geometry.

In addition, machine tables and ways can be forced out of alignment if you use the locks improperly. Tables that are not completely locked in position can be caused to shift from the forces of machining and will eventually wear.

Abbé error is a progressive fault occurring in machine tool tables or beds. Gibs and table ways can wear due to an increase in pressure at the edge of the machine way, on both the knee and at the center of the table. This causes increased wear at these points as the weight of the table moves and increases the amount of overhang.

Because the increase of weight is gradual as a table moves from center, so is the wear. The result is the formation of an arc shape along the table and knee, concave to the ways. Pressure of the gib against the way causes the gib to wear. Often when a short travel is used, retightening the gib causes localized wear of the way.

The scale attached to the table measures its horizontal motion with respect to the fixed reader head. A worn table, however, follows the curvature of the arc, resulting in an error in the movement of the workpiece relative to the cutter. In the case of the milling machine, the movement indicated by the digital measurement system is less than the actual workpiece movement and this error increases as you move up from the table and scale.

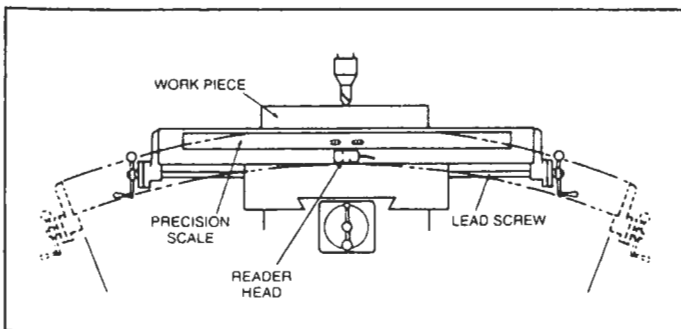

Figure 4-1. Exaggerated Abbé Error Curve of Table Travel on a Milling Machine with an Overhanging Table

4.2 HOW TO MEASURE ABBÉ' ERRORS

Most errors resulting from the preceding conditions can be measured with a simple step-by-step procedure. You will need an accurate indicator and a recently calibrated measuring standard. Procedures vary slightly from one machine to another, but the concept remains the same.

4.2.1. Step Gage Method

- Set up the step gage on the table at a height and position that coincides with that of a typical workpiece.
- Insert a dial indicator into the spindle and lower it until the indicator can contact the first reference surface of the gage. (See Figure 4-2)
- Set the dial indicator to zero.
- Turn on the console and reset it to zero (refer to Setup under Operating Procedures in Section 2).
- Raise the spindle and carefully move the table until the next reference surface is close to the dial indicator.
- Lower the spindle and carefully move the table until the indicator contacts the gage surface and registers zero.
- Record the distance moved as measured by the standard and as measured by the system and displayed on the console. Then record the difference between the two measurements.

NOTE

Make sure that each measurement reading is repeatable and that each measurement is taken in the same direction.

- Repeat steps 5 through 7 until you have moved the length of the standard.

Table 4-1 is an example of a set of recorded measurements from the standard and the display taken at 3" intervals over a 30" travel. The difference between these measurements can be plotted on a graph to determine what compensation is required to minimize the apparent error.

Table 4-1. Standard and Displayed Measurements (Inch)

Distance Measured by Standard	Measurement Displayed on Readout	Difference Between Measurements
0.0000	0.0000	0
3.0000	3.0000	0
6.0000	5.9995	-.0005
9.0000	8.9995	-.0005
12.0000	11.9990	-.0010
15.0000	14.9990	-.0010
18.0000	17.9990	-.0010
21.0000	20.9985	-.0015
24.0000	23.9985	-.0015
27.0000	26.9985	-.0015
30.0000	29.9980	-.0020

Figure 4-4 is a graph using the standard measurements to represent one coordinate, and the range of apparent error to represent the other coordinate. By plotting coincident points on the graph, a best-fitting straight line "C" can be drawn through the approximate center of the points plotted.

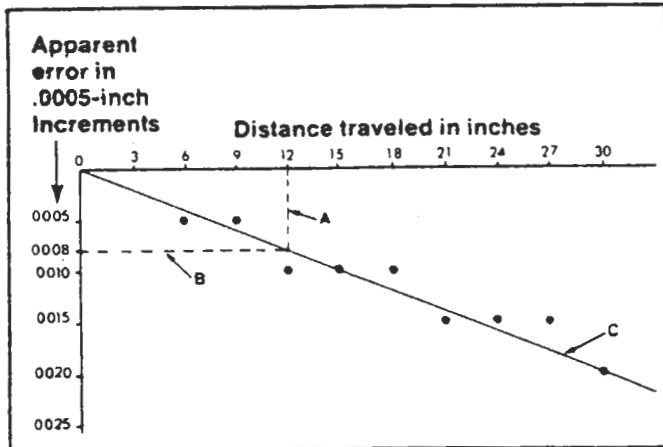

Figure 4-4. Error Slope Plotted in Inches

Drawing a vertical line "A" at any of the selected distance measurements and a horizontal line "B" where "A" intersects line "C", we determine the amount of correction necessary to reduce the total error. The following formula is used to compute the error:

$$\begin{aligned} \text{Error} &= \frac{B}{A} \\ &= \frac{-.00080 \text{ in.}}{12 \text{ in.}} \\ &= -.0000667 \end{aligned}$$

Moving the decimal point 6 places to the right, resultant correction (or compensation) factor for the error is 66.7 parts per million. Error Correction Procedure, paragraph 4.3, explains how to use this number.

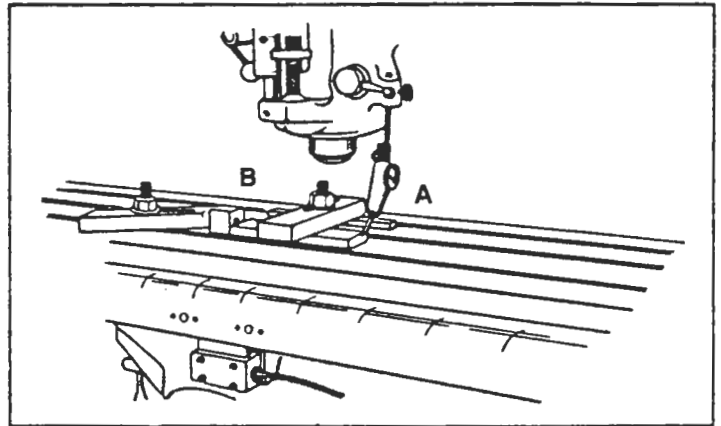

Figure 4-3. Simplified Set-up for Measuring Abbe Error

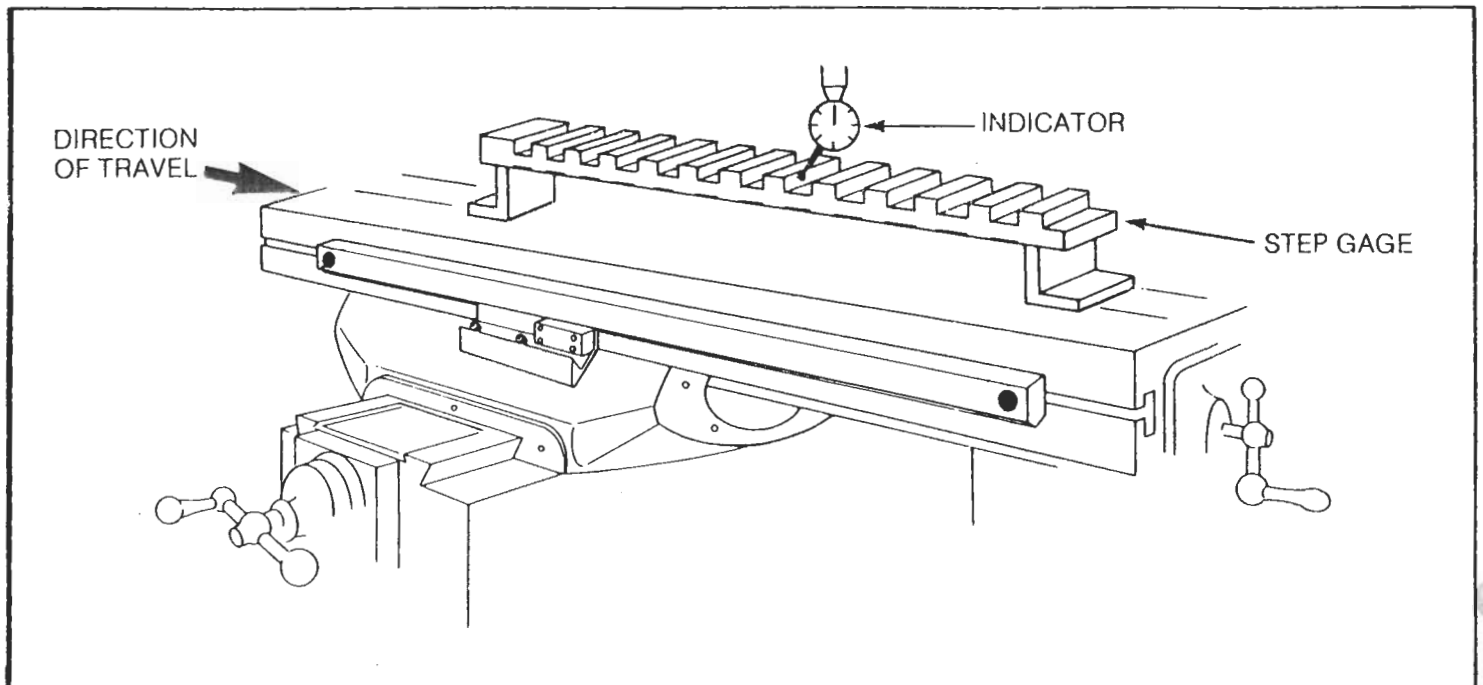

Figure 4-2. Example of Measurement Set-up Using Step Gage as a Standard to Measure Abbe Error

4.2.2 Simplified Method

1. Mount a calibrated standard as shown in Fig. 4-3 (The standard should have a recent certificate of accuracy calibration. Check for corrections to the true piece yourself. Do not rely on the opinions of others.) Mount the standard at a height at which the work is normally placed.
2. Locate the indicator at Point A as shown in Fig. 4-3. Zero both the AR-III console & indicator.
3. Lower the knee and move the table to Point B until the indicator reads zero. Record the digital value displayed on the console.
4. Divide the difference between the standard and the console by the standard's designated length. See formula to compute error. Paragraph 4.2.1.
5. Multiply this result by one million to get an error value in parts per million.
6. See Error Correction Procedure, Paragraph 4.3 to use the calculated value.

4.3 ERROR CORRECTION PROCEDURE

NOTE

Sometimes error corrections are made based on a particular workpiece weight. When there is a weight deviation, a new error factor will be introduced. Therefore, additional measurements will be required, followed by a recorrection of the error.

After computing the error, select the nearest available correction factor from the list provided in Table 4-2 (61.04 ppm in this case). Remove the cover from the console.

There are up to three nine-position switch assemblies located in the upper left corner of the axis board (see Figure 2-4). Switches 1 through 6 control the error correction factor for that corresponding axis:

- S1 Top Axis Display
- S2 Middle Axis Display
- S3 Bottom Axis Display

Refer to Table 4-2 for switch settings.

Be sure that the sign (+ or -) of the correction switch (#6) is chosen correctly.

Since in this case the readout is displaying a shorter measurement than the standard, the procedure is to add a correction factor to make them equal.

CAUTION

Check the readout display. A mistake here will double instead of cancel the error; therefore, the mistake can be very easily recognized and corrected by repositioning the sign switch (#6).

NOTES

1. When switch #6 is off (+) forward pulses are added to forward motion, and reverse pulses added to reverse motion. Switch #6 on (-) will add reverse pulses to forward motion and forward pulses to reverse motion.

Cross-check by repeating the calibration procedure after the switches have been set. If the measurement data is not sufficiently reproducible, it is a sign of inadequate machine geometry, loose or excessive local wear on ways, or too much gravity-induced deflection, particularly on large machines. Your machine tools must be thoroughly checked for misalignments.

2. Some consoles have switches with slightly different labeling. For these switches, the "open" position corresponds to OFF.

Table 4.2. Switch Assembly S1 Settings for Error Correction and Diameter Readout Selection

Correction Factor (ppm)	#1	#2	#3	#4	#5	#6
No Correction	Off	Off	Off	Off	Off	Off
+ 15.26	On	Off	Off	Off	Off	Off
- 15.26	On	Off	Off	Off	Off	On
+/- 30.52	Off	On	Off	Off	Off	Off/On
+/- 45.78	On	On	Off	Off	Off	Off/On
+/- 61.04	Off	Off	On	Off	Off	Off/On
+/- 76.29	On	Off	On	Off	Off	Off/On
+/- 91.55	Off	On	On	Off	Off	Off/On
+/- 106.81	On	On	On	Off	Off	Off/On
+/- 122.07	Off	Off	Off	On	Off	Off/On
+/- 137.33	On	Off	Off	On	Off	Off/On
+/- 152.59	Off	On	Off	On	Off	Off/On
+/- 167.85	On	On	Off	On	Off	Off/On
+/- 183.11	Off	Off	On	On	Off	Off/On
+/- 198.36	On	Off	On	On	Off	Off/On
+/- 213.62	Off	On	On	On	Off	Off/On
+/- 228.88	On	On	On	On	Off	Off/On
+/- 244.14	Off	Off	Off	Off	On	Off/On
+/- 259.40	On	Off	Off	Off	On	Off/On
+/- 274.66	Off	On	Off	Off	On	Off/On
+/- 289.92	On	On	Off	Off	On	Off/On
+/- 305.18	Off	Off	On	Off	On	Off/On
+/- 320.43	On	Off	On	Off	On	Off/On
+/- 335.69	Off	On	On	Off	On	Off/On
+/- 350.95	On	On	On	Off	On	Off/On
+/- 366.21	Off	Off	Off	On	On	Off/On
+/- 381.47	On	Off	Off	On	On	Off/On
+/- 396.73	Off	On	Off	On	On	Off/On
+/- 411.99	On	On	Off	On	On	Off/On
+/- 427.25	Off	Off	On	On	On	Off/On
+/- 442.50	On	Off	On	On	On	Off/On
+/- 457.76	Off	On	On	On	On	Off/On
Diameter (2X)	On	On	On	On	On	Off

SECTION 5 MAINTENANCE

5.1 GENERAL

This section is primarily devoted to troubleshooting the system. Table 5-1 will assist you in isolating the problem and making the proper repair. Figures 5-1 and 5-2 identify electronic parts and test points on both the typical axis/display printed-circuit board and the power supply board.

NOTE

All of the procedures that follow in this section are based on a 2-axis system.

The ACU-RITE III digital measuring system can be conveniently serviced because of its modular design. Therefore, any malfunction can usually be traced to an easy-to-replace, modular part. Some malfunctions that may occur in the ACU-RITE system can be corrected in the field with a minimum of downtime, if you have some electrical or electronic background. Replacement of circuit boards and reading head assemblies are relatively simple.

5.2 Cover Removal Procedure

- a. Ensure console is off; disconnect power cord.
- b. Remove two screws located on each side of console.
- c. Lift off top cover. (Nameplate band will lift off with the cover.)

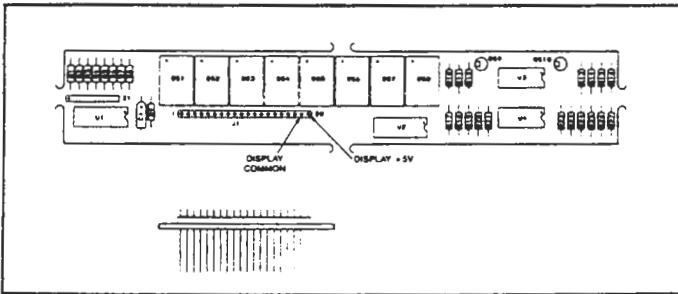

Figure 5-1. Test Points on Display Board

5.3 PRELIMINARY TROUBLESHOOTING

All malfunctions will exhibit symptomatic readings on the digital display. However, different causes can sometimes produce similar symptoms. A simple diagnostic procedure combined with the correct interpretation of the symptoms will aid in isolating the faulty component. The first step is to determine the location of the malfunction by switching the reading head cables from one axis to the other. If the symptoms change from one display to the other, the malfunction is in the reading head or scale assembly. If the symptoms do not change axes when the cables are switched, the malfunction is in the console.

CAUTION

Problems in the console that cannot be remedied by simple parts replacement should be handled by a qualified electronic technician and must be referred to your ACU-RITE distributor service representative.

5.4 SYSTEM TROUBLESHOOTING

Table 5-1 contains a list of possible problems that may occur in the system. Each is followed by the probable cause and procedures used to remedy the problem. If "a" is not the remedy, proceed to "b," "c," and so on. Be sure to read Preliminary Troubleshooting, paragraph 5.4, before using this table.

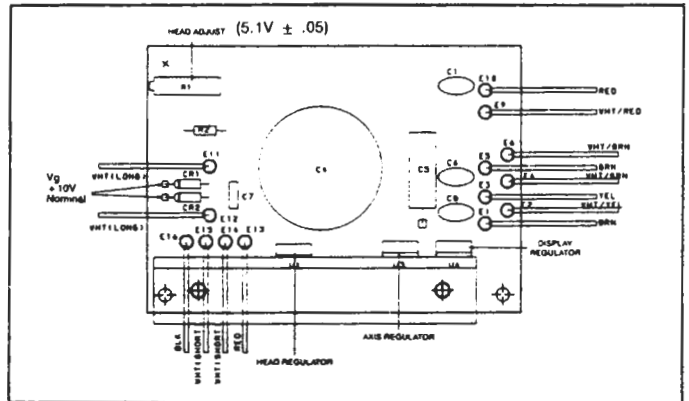

Figure 5-2. Test Points on Power Supply Board

Table 5-1. System Troubleshooting

Problem	Probable Cause	Remedy
a. Console is turned on, but fault indicators do not light up.	<ol style="list-style-type: none"> 1. Improper or no line voltage at the power outlet. 2. Power cord not plugged, or improperly plugged, into the power outlet. 3. A blown fuse. 	<p>Check the line voltage at the power outlet. It should match the rating on the serial number plate (rear of console).</p> <p>Check to make sure that the 3-prong power cord is properly plugged into the power outlet.</p> <p>Check the fuse on the console back panel. (Spring inside fuse will be compressed if blown.) If necessary, replace with proper fuse as indicated on back panel of instrument.</p>
b. Console is turned on, but one fault indicator does not light up.	<ol style="list-style-type: none"> 1. Internal connection is not making proper contact. 2. Voltage supply(ies) on the axis board inadequate 3. Component-level repair or replacement is required. 	<p>Disconnect the line power cord, remove the console cover, inspect all inside connections for proper contacts. Check the axis board to be sure the display boards are seated in their connectors properly. Unplug and reinsert the connectors.</p> <p>For qualified electronic technician only: Check the +10V D.C. at points shown in Figure 5-1 (may range from +8.5V to 14.0V) and the +5V D.C. supplies on each display board at points shown in Figure 5-1.</p> <p>Contact your ACU-RITE distributor service representative for repair or replacement of the faulty components or repair of the console.</p>
c. Fault indicator lights up, but no digits appear when ZERO RESET key is pushed.	<ol style="list-style-type: none"> 1. Internal connection is not making proper contact. 2. Axis printed-circuit board is faulty. 3. Voltage supply(ies) on the axis board inadequate. 4. Component-level repair or replacement is required. 	<p>Disconnect the line cord, remove the console cover, inspect all inside connections for proper contact. Unplug and properly reinsert the keyboard cable.</p> <p>Contact your ACU-RITE distributor service representative for repair or replacement of the faulty components or repair of the console.</p> <p>For qualified electronic technician only: Check the +10V D.C. and +5V D.C. supply voltages (see "b." 2.).</p> <p>Contact your ACU-RITE distributor service representative for repair or replacement of the faulty component or repair of the console.</p>
d. Only one digit or sign lights up.	<ol style="list-style-type: none"> 1. Faulty display oscillator and/or LSI chip. 2. Component-level repair or replacement is required. 	<p>Turn off the console power immediately. Replace the axis board.</p> <p>Contact your ACU-RITE distributor service representative for repair or replacement of the faulty component or repair of the console.</p>
e. One or several digits or segments do not light up.	<ol style="list-style-type: none"> 1. Faulty axis or display board. 2. Component-level repair or replacement is required. 	<p>Disconnect line cord and replace the axis or display board.</p> <p>Contact your ACU-RITE distributor service representative for repair or replacement of the faulty component or repair of the console.</p>
f. Only one axis will not preset properly.	<ol style="list-style-type: none"> 1. The procedure for presetting has not been done properly. 2. Faulty connection between the keyboard and the axis board. 3. Axis board is faulty. 4. Component-level repair or replacement is required. 	<p>Check the procedure for presetting in the Operation section, paragraph 3.3.3. Repeat, if necessary.</p> <p>Disconnect the line cord and remove console cover. Unplug and check the cable connection between the keyboard and the axis board. Check for bent or broken pins.</p> <p>Contact your ACU-RITE distributor service representative for repair or replacement of the faulty component or repair of the console.</p> <p>Contact your ACU-RITE distributor service representative for repair or replacement of the faulty components or repair of the console.</p>

Table 5-1. System Troubleshooting (continued)

Problem	Probable Cause	Remedy
g. Console will not preset properly.	1. The procedure for presetting has not been done properly.	Check the procedure for presetting in the Operation section, paragraph 3.3.3. Repeat, if necessary.
	2. Faulty connection between the keyboard and the axis board.	Disconnect the line cord and remove console cover. Unplug and check the cable connection between the keyboard and the axis board. Check for bent or broken pins.
	3. Faulty keyboard assembly.	Replace the keyboard assembly.
	4. Component-level repair or replacement is required.	Contact your ACU-RITE distributor service representative for repair or replacement of the faulty component or repair of the console.
h. Counting occurs only on least significant digits.	1. Faulty reading head assembly.	Interchange reading head cables between axes to isolate the problem to the reading head assembly or console. Replace reading head, if necessary. See procedures later in this section.
	2. Faulty connection from axis board to input connector.	Disconnect line cord and check connection at rear of axis board and input connector for loose wires or plugs. Correct if necessary.
	3. Component-level repair or replacement in the console is required.	Contact your ACU-RITE distributor service representative for repair or replacement of the faulty components or repair of the console.
i. Counting occurs in one direction only.	1. Faulty reading head assembly.	Interchange reading head cables between axes to isolate the problem to the reading head assembly or console.
	2. Reading head is not aligned correctly.	Check the reading head alignment. Refer to appropriate scale installation manual (A-R/1, A-R/5 or Mini-Scale) for details of installing and aligning the reading head.
	3. Axis board is faulty.	Disconnect line cord and replace the axis board.
	4. Component-level repair or replacement is required.	Contact your ACU-RITE distributor service representative for repair or replacement of the faulty components or repair of the console.
j. Counting occurs in one measurement mode but not the other.	1. Axis board is faulty.	Disconnect line cord, then replace the axis board.
	2. Component-level repair or replacement is required.	Contact your ACU-RITE distributor service representative for repair or replacement of the faulty component or repair of the console.
k. Absolute/incremental mode selection does not function properly.	1. Specific operating procedure has been done incorrectly.	Check Operating Procedure, paragraph 3.5., and repeat, if necessary, to be certain that all steps have been done correctly.
	2. Component-level repair or replacement is required.	Contact your ACU-RITE distributor service representative for repair or replacement of the faulty component or repair of the console.
l. System will not repeat to within a least count.	1. Scale assembly is not aligned correctly.	Check the spar brackets for alignment and stability. Refer to appropriate scale installation manual (A-R/1, A-R/5 or Mini-Scale) for details of installing and aligning the reading head.
	2. Low supply voltage.	For qualified electronic technician only: Check for low +5V D.C. (for reading head supply voltage). See Figure 5-1 (also see "b".2.).
	3. Glass scale is dirty.	Gently clean the scale with a cotton swab and isopropyl (rubbing) alcohol to remove foreign matter. Keep swab saturated while cleaning.
	4. Reading head is defective.	Replace the reading head. Refer to appropriate scale installation manual (A-R/1, A-R/5 or Mini-Scale) for Mounting of Reading Head or to Reading Head Replacement, paragraph 5.7. Be sure to install temporary alignment bracket.